

# PENTAX®

## P50



Thank you very much for choosing the Pentax camera. Needless to say, your camera is a sophisticated, precision instrument built to give long-lasting, reliable service and will serve you well if you treat it right, with proper handling and reasonable care. So, please read this operating manual carefully through and familiarize yourself with all the features and functions it has to offer. We hope you will enjoy fine photography with this new camera for many years to come.



## TABLE OF CONTENTS

---

Nomenclature .....	2
Features .....	4

### PREPARATIONS

Inserting batteries .....	8
Attaching and detaching lens .....	10
Film-wind lever .....	11
Main switch and shutter-release button .....	12
Film .....	13
Loading film .....	14
Unloading film .....	17
Grip .....	18
Strap and soft case .....	19

### BASIC OPERATIONS

Viewfinder displays .....	21
Holding camera .....	22
Focusing .....	23
SMC Pentax-A (A-series) lens .....	25
Setting exposure mode .....	26
Shooting in Programmed-AE mode .....	28
Shooting in Aperture-Priority-AE mode .....	32
Shooting in Metered-Manual mode .....	34
Warning displays in viewfinder .....	38
Using Pentax dedicated auto flash .....	40
Using Programmed Auto Flash mode .....	41

### ADVANCED OPERATIONS

Self-timer .....	44
Using 100 (1/100 sec.) .....	45
Using B (Bulb) setting .....	46
Infrared index mark .....	47
Exposure-memory lock .....	48
Exposure compensation .....	50
Depth of field .....	53
Depth-of-field preview .....	54
Programmed-AE diagram, metering range and shutter/aperture coupling range .....	56
Diopter correction, mount adapter K .....	58
Precautions on batteries .....	59
Specifications .....	60
Taking care of your camera .....	62
Warranty policy .....	64

## NOMENCLATURE

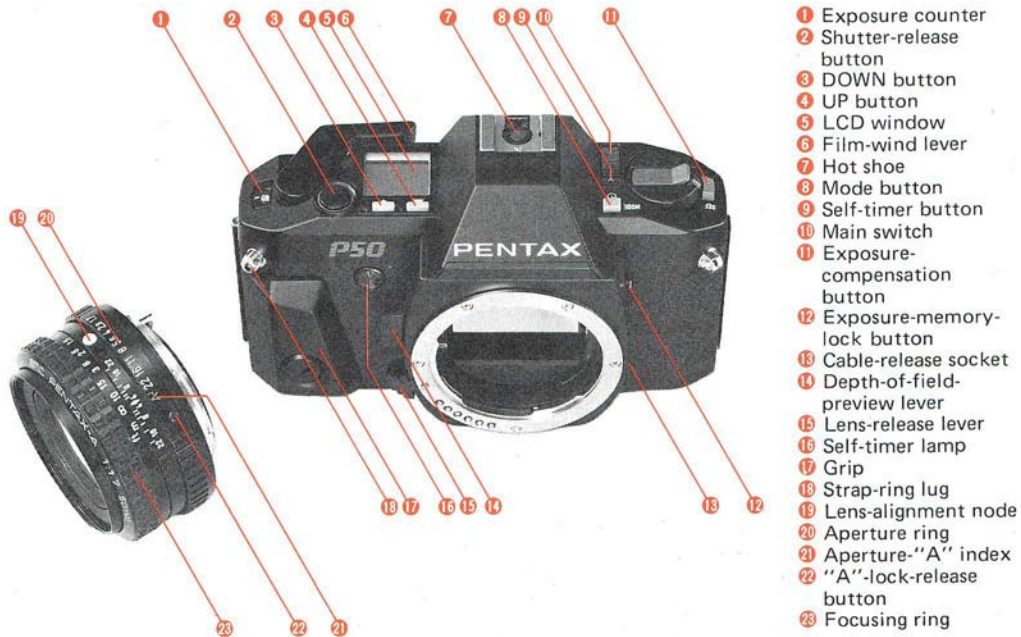

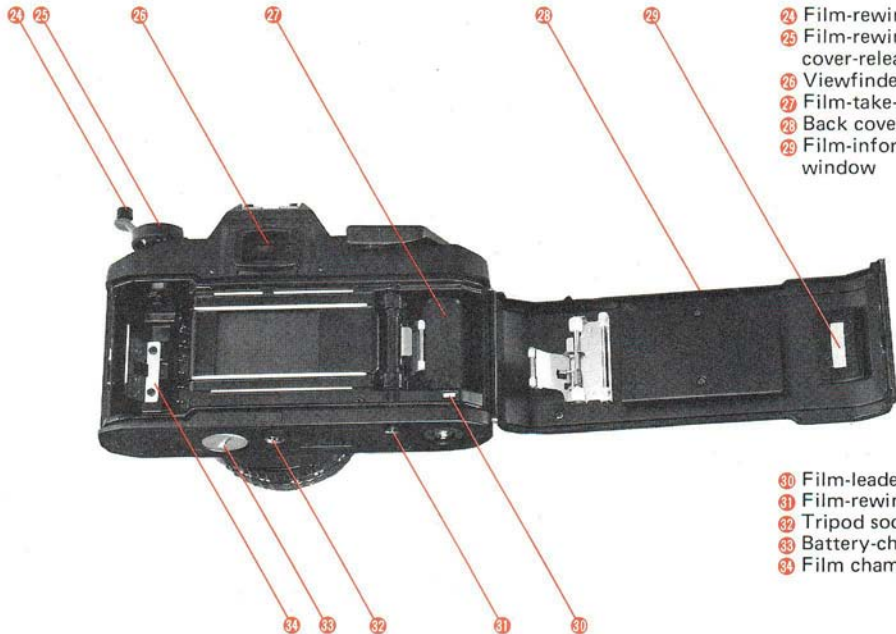

- 24 Film-rewind crank
- 25 Film-rewind/Back-cover-release knob
- 26 Viewfinder eyepiece
- 27 Film-take-up spool
- 28 Back cover
- 29 Film-information window

- 30 Film-leader-end mark
- 31 Film-rewind button
- 32 Tripod socket cap
- 33 Battery-chamber cap.
- 34 Film chamber

## FEATURES

When this camera is combined with an SMC Pentax-A lens, it offers five exposure modes: two Programmed AE modes, Aperture-Priority AE, Metered Manual, and Programmed Auto Flash modes. The Programmed AE mode can be used by setting the lens aperture to A, and the Metered Manual or Aperture-Priority AE mode by setting the aperture to an f-stop other than A.

- When using a Pentax K- or Kf-mount lens on your camera, use the Aperture-Priority AE or Metered Manual mode.



### Programmed AE Mode

The camera automatically selects the proper combination of shutter speed and aperture for correct exposure, simultaneously changing the combination according to the brightness of a subject. This mode is suitable for those who do not want to be bothered by setting exposure controls but want to concentrate on shutter chances. This camera offers the following two kinds of program modes.



### Program Action Mode

The Program Action mode enables you to use faster shutter speeds. It is suitable for those who wish to take "action" photographs, and becomes a big help when you wish to avoid camera-shake that causes blurred pictures.



Program Depth Mode

The Program Depth mode enables you to take pictures having greater depth of field. Use this mode when you wish to take pictures in focus from foreground to background.

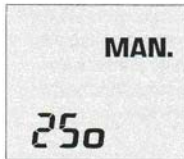

Metered Manual Mode

Guided by the meter indication in the viewfinder, you can adjust the shutter speed or aperture to obtain correct exposure. If necessary, you can also make deliberate over- or underexposure.

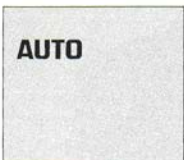

Aperture-Priority AE Mode

If you set the lens aperture to the f-stop you desire, the camera automatically sets the proper shutter speed according to the brightness of a subject. This mode is suitable for taking pictures for which the depth of field is very important, such as portraits, etc.

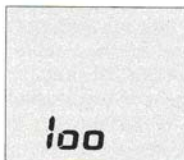

Programmed Auto Flash Mode

If you use a Pentax dedicated auto flash unit with the camera set to the Programmed AE mode, the camera automatically sets the proper shutter speed and aperture for correct flash exposure upon completion of flash charging.

## PRECAUTIONS

- This camera does not operate unless the batteries are correctly placed in the chamber. Be sure to insert them correctly. Also make sure the main switch is set to ON when you start operating the camera.
- Although most electronic flashes made by other manufacturers can be used with your camera, Pentax dedicated flashes offer more convenient ways of operation, with an exception that TTL Auto Flash photography is not possible with this camera.
- When using the accessories such as Auto Extension Tubes, Microscope Adapter, etc. that are mounted between the camera body and lens, set the camera to the Aperture-Priority AE or Metered Manual mode. The Programmed AE mode is not workable.
- To read the exposure before you release the shutter with the Motor Drive A attached, depress the camera's shutter-release button half-way. If you depress the Motor Drive's trigger button, the shutter speed will not appear in the viewfinder and LCD window until after the exposure is made.





# PREPARATIONS

## INSERTING BATTERIES

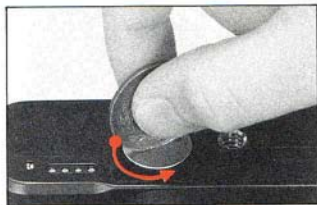

This camera is powered by two 1.5-volt alkaline or silver-oxide mini-batteries.

- Open the battery chamber cover by turning it counter-clockwise with a coin.
- Insert the two batteries into the chamber with their (+) sides facing downward, and replace the cover.

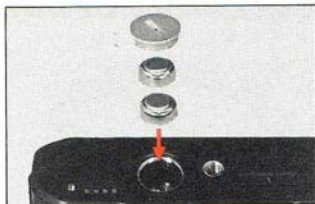

- As illustrated, turn the meter on by sliding the main switch in the direction of the arrow.

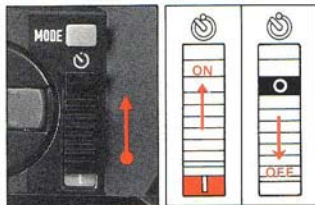

- Press the shutter release button halfway and make sure that a shutter speed appears in the viewfinder.

### Timer switch

The built-in timer switch automatically turns the meter off in about ten seconds after you release your finger off the shutter button.

### Battery check

If no shutter speed is displayed in the viewfinder even with a slight pressure on the shutter button, the batteries have no power or may be improperly inserted.

### When batteries weaken

When the batteries are becoming weak, the shutter speed displayed in the viewfinder starts to blink slowly at the speed of once per second. If so, replace the batteries immediately. If the batteries are completely exhausted, the shutter button does not release the shutter.



## ATTACHING AND DETACHING LENS

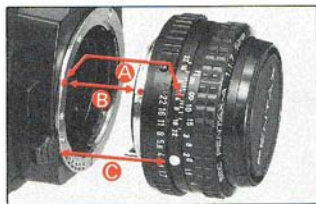

To mount or interchange Pentax K, KA and Kf mount lenses, follow the steps below.

- Remove the body mount cap and the rear lens cap. If the finder cap is still on the eyepiece, remove it.
- Align the red dot on the camera body with the red dot on the lens (See **A**, **B**). Seat the lens in the body mount and turn it clockwise until the lens locks with a click. When mounting the lens in dim light, method (**C**) is recommended. This method allows lens mounting by touch.

Align the raised node on lens barrel with the lens release by touch. Then turn and lock as above.

- To remove the lens cap, press in on the notches at both sides.
- To remove the lens, press the lens release lever toward the camera body while turning the lens counter-clockwise.
- After removing a lens from the camera body, replace the front and rear lens caps to protect the lens from dust and stains.

**Note:** Don't damage or stain the electrical contact points on the mount face. When they become stained, wipe them with a clean, dry cloth.

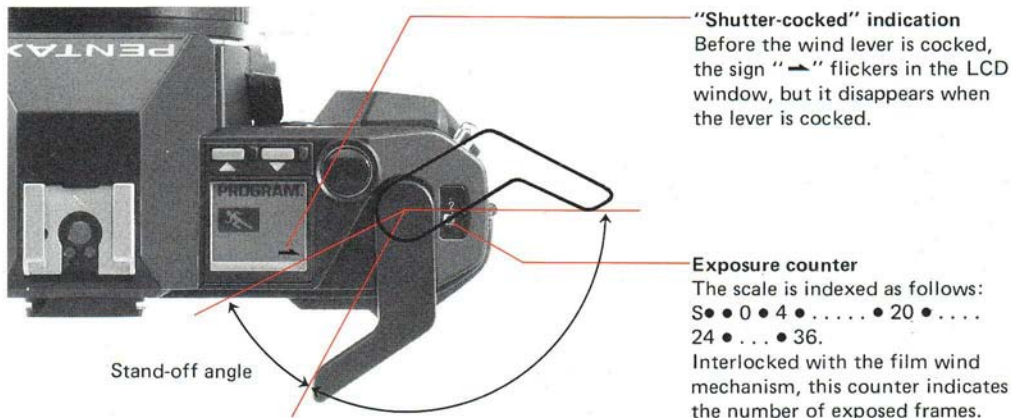

### Setting the wind lever for rapid shooting

The film wind lever can be set at the stand-off position for faster film advance. Even if you remove your thumb from the lever, it remains at the stand-off angle, ready for the next quick shot. After completing a series of pictures, the lever should be pushed in to the original position.

### Film advance stroke

The film wind lever should be thrown as far as it goes.

**Note:** The wind lever may stop in the middle of a stroke when the film comes to its end. Do not force the lever and rewind the film, leaving the lever as it is.

## MAIN SWITCH AND SHUTTER-RELEASE BUTTON



- **Main switch**

To release the shutter, be sure to set the main switch to ON. When the switch is set to OFF, the shutter cannot be released.

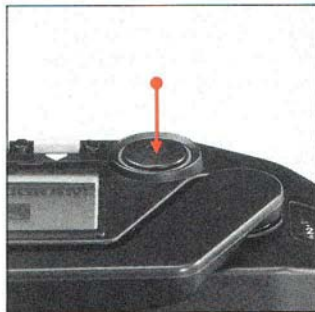

- **Shutter-release button**

As you set the main switch to ON and depress the shutter-release button halfway, the meter will be switched on. As you continue to depress the button, the shutter will be released. Since the meter has the timer switch, it will automatically be switched off about ten seconds after you release your finger off the shutter button.

**DX FILM**

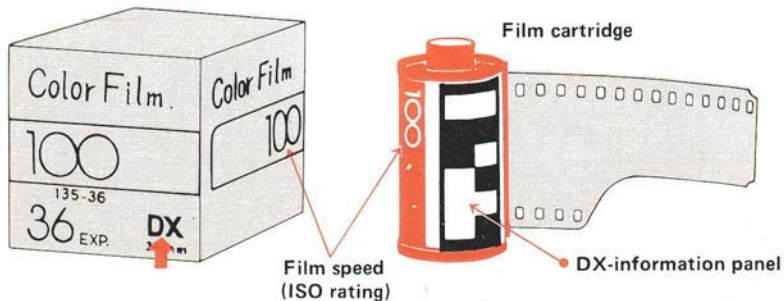

This camera is designed to use only DX-coded films with ISO ratings from 25 to 1600, and when such films are loaded, their ISO film speeds are automatically set in the camera.

- When non-DX-coded film is loaded into the camera, the film speed is automatically set to 100, no matter what ISO rating it has. (In other words, the only non-DX film that can be used with this camera is one with ISO 100.)

## LOADING FILM



Always load or unload film in the camera in a shady spot, or shield it from direct sunlight with your body.

- As illustrated, unfold the rewind crank by pushing it with your finger-nail.
- Pull the rewind knob upwards until the back cover snaps open.
- Slide the film cartridge into the film chamber with the flat side up. Lock the cartridge in place by pushing the rewind knob down, rotating it slightly making sure that it grips the spool.

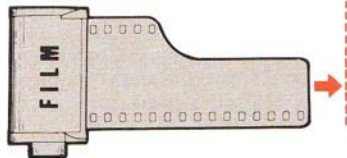
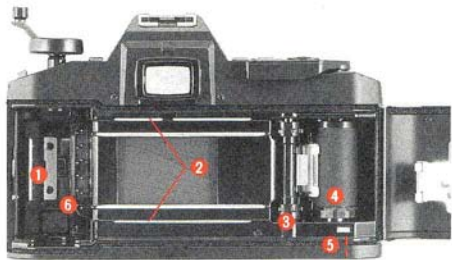

- |                  |                        |
|------------------|------------------------|
| 1 Film chamber   | 4 Spool teeth          |
| 2 Guide rails    | 5 Film leader end mark |
| 3 Sprocket teeth | 6 DX-information pins  |

Keep the DX-information pins free from scratches, dirt, dust, etc.



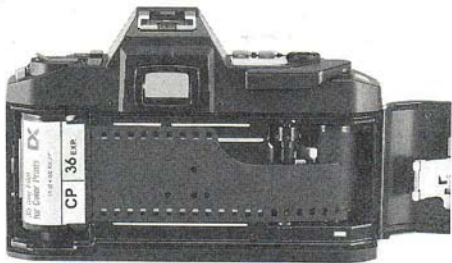

- As illustrated, pull the film leader out so that its end aligns with the 5 film leader end mark (red bar); in other words, bring the film leader end within the length of the bar.
- Make sure that the perforations on the bottom side of the film have engaged the 3 sprocket teeth as well as the 4 spool teeth.
- Also make sure that the film is properly placed between the two 2 guide rails.
- Take up any slack left in the film so that the film is flat as shown, by rewinding it slightly into the cartridge.
- When a film with a higher ISO number is loaded, do not leave the camera out of the case for a long time.

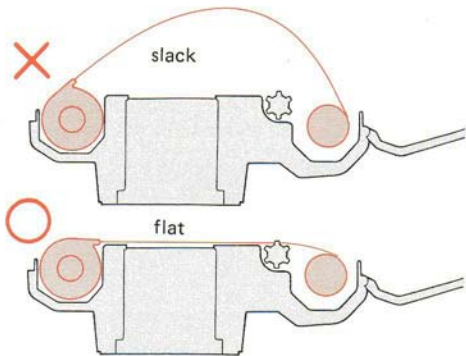



- Close the back cover, making sure that it has snapped firmly in place.



- You can see through the film-information window on the back cover what type of film is in the camera.
- Cock the film wind lever while checking to see if the film rewind knob turns in the direction of the arrow.



- Repeat making blank exposures until "0" appears in the exposure counter. The next frame is ready for the first shot.

## UNLOADING FILM

When you reach the end of the roll, the film wind lever will stop moving abruptly — maybe at some point in the middle of a stroke. Do not force the lever beyond the number of exposures shown on the cartridge.

- Press the film rewind button recessed in the base of the camera.
- Unfold the crank and turn it clockwise all the way until you feel it loosen when the film leader is released from the take-up spool.
- When the rewinding is over, lift the rewind knob sharply to open the back cover, and take the cartridge out.

If you accidentally opened the back cover without rewinding the film, close it immediately, since the film except the last several frames might be saved.

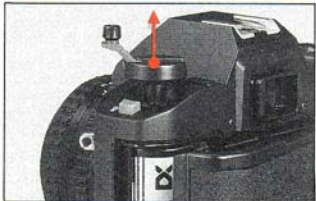
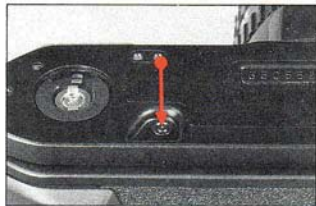

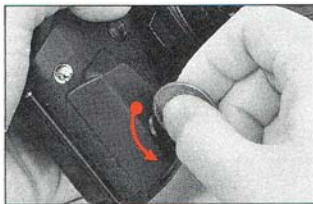

- To remove the grip, loosen the grip mount screw fully, and with the camera facing downward, slide the grip up until it comes off.

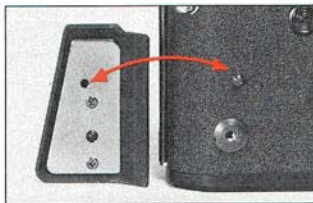

- To mount the grip, fit the grip mount socket (on the rear side of the grip) to the grip lug on the camera.

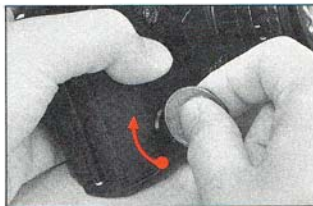

- Align the grip mount screw with the grip mount receptacle on the camera, and keeping the grip pushed down as indicated by the arrow, tighten the grip mount screw with a coin.

**Note:** The grip should be removed from the camera body when using the Motor Drive A or the Winder ME II.

## STRAP AND SOFT CASE

- To attach the strap to the camera, first pass the end of the strap through the strap lug on the camera, fold it back, then pass it through the strap ring, and through the strap clasp and the last ring. The strap end may be passed through the inside or outside of the clasp.
- Remove the front cover from the back cover. Put the camera in the back cover and put both case hooks around the camera's strap eyelets. The camera is now held securely in place.
- The soft case for this camera is available in two sizes: P-S for the camera with a standard 50mm lens, and P-L for the camera with a zoom lens such as 35 - 70mm.

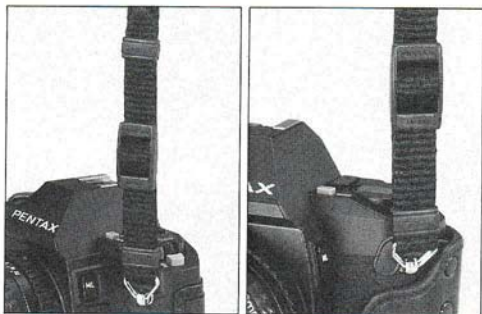

# **BASIC OPERATIONS**

## VIEWFINDER DISPLAYS

Shutter-information LEDs on the left-hand side of the viewfinder glow or flicker to indicate various exposure data, as described here.

LED = Light-Emitting Diode

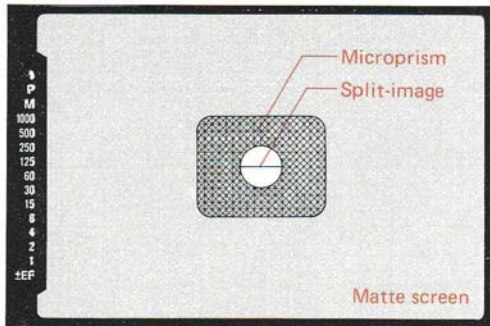

- ⚡ ..... Indicates flash is ready.
- P ..... Programmed AE mode
- M ..... Metered Manual mode
- 1000 ~ 1 ..... Shutter speeds from 1/1000 to 1 sec.
- “1000” (flickers)... Overexposure (flickers four times per sec.)
- “1” (flickers) ..... Underexposure (flickers four times per sec.)
- The two signs above indicate the brightness of the subject is beyond the shutter-aperture coupling range or beyond the metering range.
- “30 ~ 1” (glows in orange) ..... Camera-shake warning
- Shutter speed in use (flickers) ..... Memory lock
- ±EF ..... Exposure compensation
- No display for 100 and B

## HOLDING CAMERA

Proper holding of the camera is essential to minimize camera shake which causes blurred pictures. Practice holding and operating your camera before inserting your first film cartridge. Generally there are three basic ways to hold the camera. In any case, hold the camera tightly to your face with your hands. The grips on this camera will help you keep a steady hold on your camera. Release the shutter gently while slowly breathing out. Strong pressure on the shutter

release button may cause blurred photographs. Take a secure, well-balanced posture without straining yourself. The portion marked O in the illustration should be drawn to your body. It is a good idea to stabilize your body and the camera using a tree, building wall, table, etc. For long exposures or while using telephoto lenses, it is recommended to use a tripod in order to reduce camera shake to a minimum.

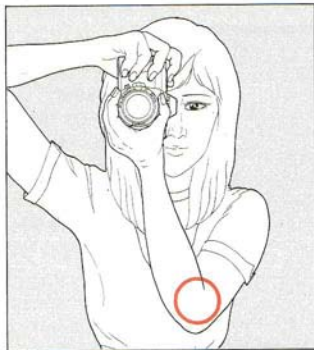
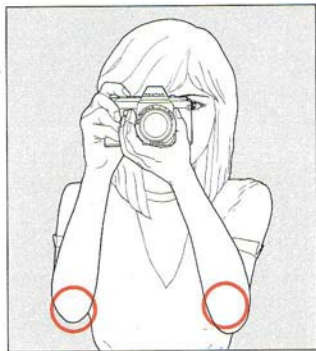



## FOCUSING

You can focus in three ways, with the split-image, microprism, and/or matte field. To focus using the split-image, turn the focusing ring until the two images in the split-image circle at the center of the focusing screen are perfectly aligned. When using the microprism field, focus until the glitter disappears from inside the collar. With the matte field, focus until the image on the matte field appears sharp and crisp.

**Note:** If the maximum aperture of the attached lens is smaller than  $f/5.6$  (for example,  $f/8$  as in the case of a long telephoto), it is easier to focus on the matte field since the split-image and microprism field areas become much too dark for satisfactory focusing.

### Diopter adjustment for viewfinder eyepiece

People who wear eyeglasses due to myopia, hypermetropia or presbyopia, sometimes find it difficult to focus while wearing their glasses. In this case, use the accessory diopter correction lenses M (See page 58).

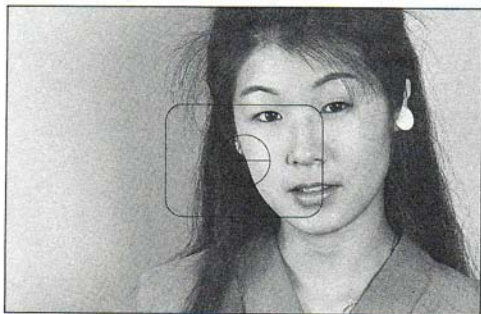
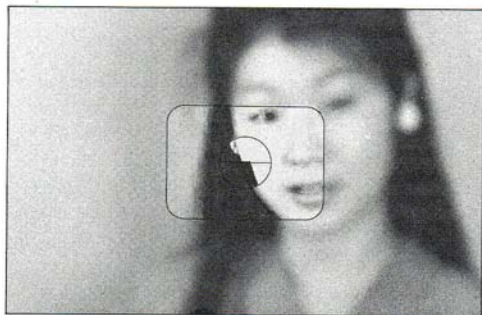

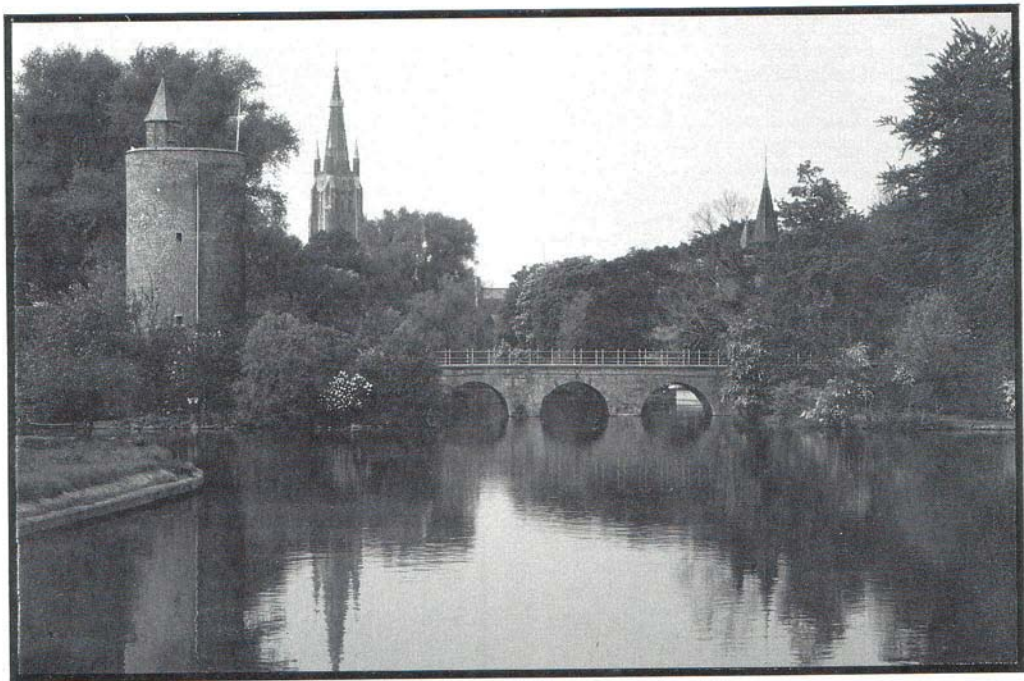

## SMC PENTAX-A (A-SERIES) LENS

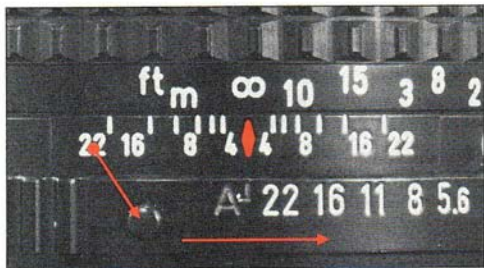

To set the lens to "A" position, align the aperture-"A" index (green line) with the distance/aperture index (♦) while depressing the "A"-lock button. To unlock the lens from the "A" position, move the aperture ring to the left while depressing the "A"-lock button.

Depending on whether the aperture is set to "A" or elsewhere, the following exposure modes are available.

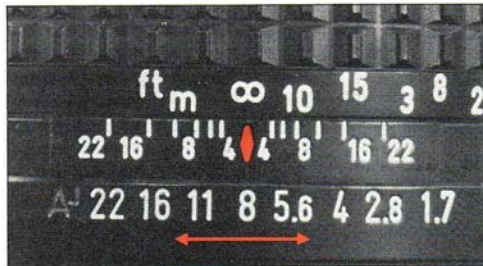

- "A" setting — ● Programmed AE modes (Program Action & Program Depth)
- Each f-stop — ● Aperture-Priority AE mode  
● Metered Manual mode  
● 100 (1/100 sec. fixed)  
● B (Bulb)

## SETTING EXPOSURE MODE

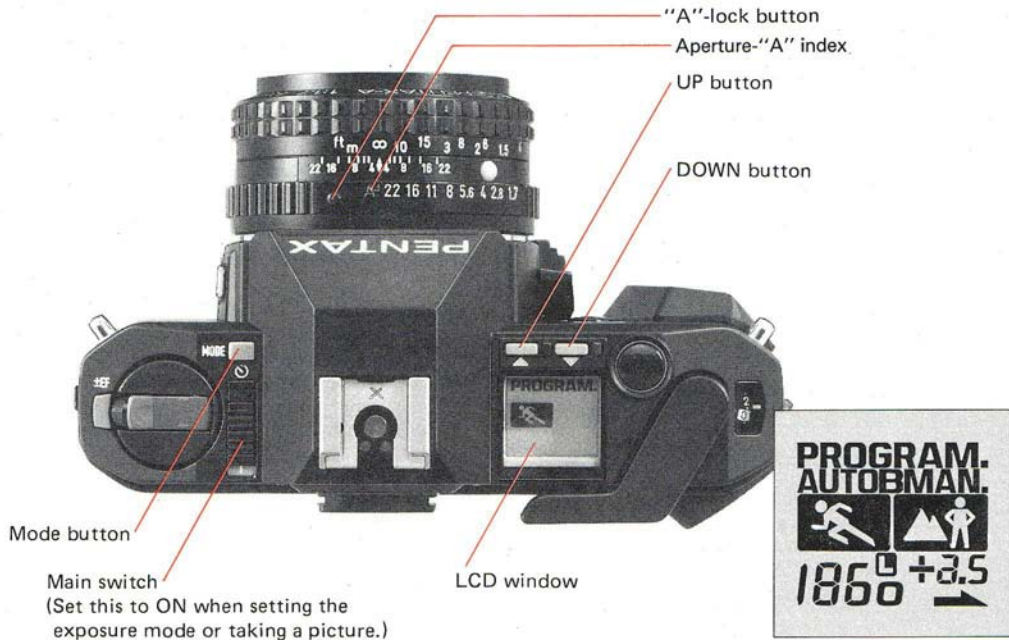

- The LCD window displays (1) exposure mode, (2) shutter speed, (3) exposure-compensation indication, (4) manual-shutter-speed lock, and (5) shutter-cocked indication.

### Setting Exposure Mode

The exposure mode automatically changes each time you depress the UP (▲) or DOWN (▼) button while depressing the mode button.

### Setting Shutter Speed

In the Metered Manual mode, set the shutter speed you desire by depressing the UP or DOWN button. The shutter speed changes by one step each time you depress the button, and as you keep depressing the button the shutter speed changes in succession. The UP button keeps showing the shutter speed up to "1000" (1/1000 sec.) in the LCD window, while the DOWN button up to "1" (one sec.).

When the aperture is set to "A"



= Program Action



= Program Depth



When the aperture is set to each f-stop other than "A"

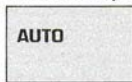

= Aperture-Priority AE

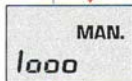

= Metered Manual

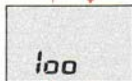

= 100  
(fixed at 1/100 sec.)

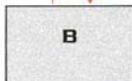

= Bulb



## SHOOTING IN PROGRAMMED AE MODE

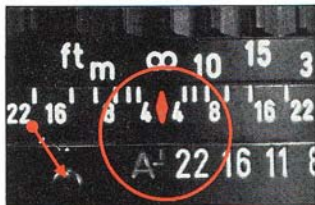

- To set the camera to the Programmed AE mode, align the lens's aperture-"A" index (green line) with the distance/aperture index (♦).



- Turn the main switch on. The LCD window displays the Program Action or Program Depth mode.

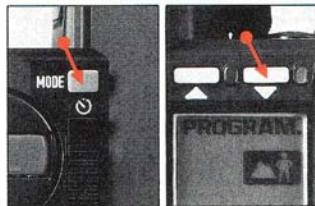

- To switch the mode from Program Action to Program Depth, push the DOWN button (▼) while depressing the mode button.

- As you depress the shutter button halfway, "P" and a shutter speed appear in the viewfinder, and the shutter speed also appears in the LCD window. As you further depress the shutter button, the shutter will be released at the shutter speed displayed to take a picture.

When the subject is too bright or too dark, "1000" or "1" flickers in the viewfinder as a warning. When the subject is so dark that the shutter speed of "30" or slower lights up in orange, there is a danger of camera-shake, and the use of a tripod or flash is recommended. (For details, refer to pages 40~42.)

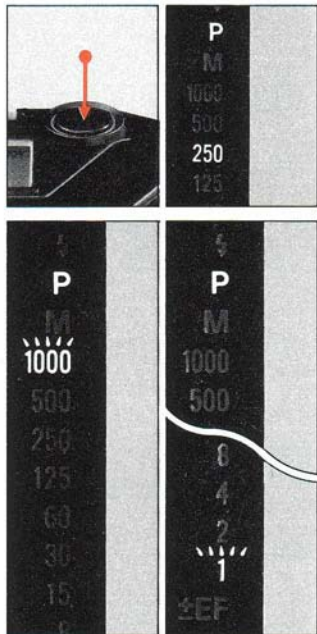

## PROGRAM ACTION MODE

# PROGRAM.



# 1000

This mode enables you to shoot at fast shutter speeds. So it is suitable for taking ordinary snapshots, capturing fast-moving subjects such as sports scenes, animals, etc., or minimizing camera-shake and vibration to prevent blurred, unsharp pictures.





## PROGRAM DEPTH MODE

# PROGRAM.



# 60

This mode enables you to shoot subjects requiring as great a depth of field as possible. So it is suitable for taking pictures of people with the background (buildings, landscapes, etc.) also in focus.



## SHOOTING IN APERTURE-PRIORITY AE MODE



- Set the aperture to the f-stop you desire by turning the aperture ring. With the 50mm f/1.7 lens, you can set it anywhere between f/1.7 and f/22.

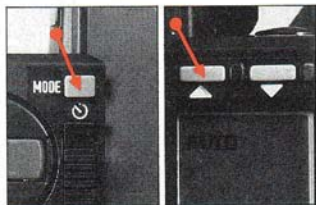

- This exposure mode displays "AUTO" in the LCD window. If anything else is on display, keep depressing the UP button while depressing the mode button until "AUTO" appears in the LCD window.

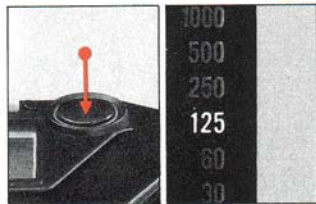

- As you depress the shutter button halfway, the shutter speed is displayed in the viewfinder and LCD window. As you depress the shutter button further, the shutter will be released.

When the subject is too dark or too bright, "1000" or "1" in the viewfinder flickers as a warning. Stop down the lens (toward f/22) or open it (toward f/1.7). When "1000" or "1" stops flickering, you are ready to shoot.

When the subject is dark, use the Pentax dedicated flash. (For details, refer to page 40.)

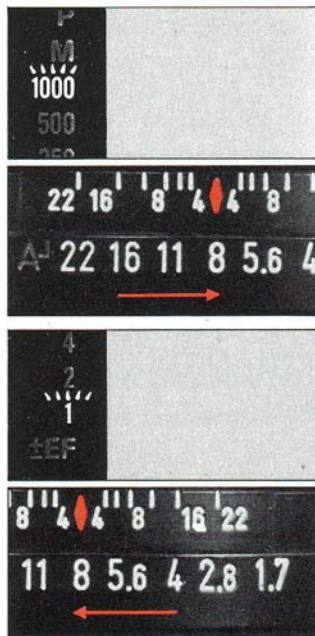



- Set the lens aperture to an f-stop other than A. The LCD window displays "MAN." and a shutter speed. If anything else is on display in the window, keep depressing both the mode button and the UP or DOWN button until "MAN." appears.

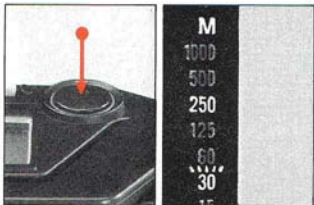

- As you depress the shutter button halfway, "M" and shutter speed are displayed in the viewfinder. If, as shown in the photo, two shutter speeds appear, one glowing and the other flickering, it indicates incorrect exposure. In this case, change the shutter speed or the aperture until the flickering shutter speed disappears. If only one shutter speed remains lit, correct exposure is assured.

#### When determining shutter speed first

Set the shutter speed you desire by pushing the UP or DOWN button. As you turn the aperture ring until the shutter-speed display in the viewfinder changes from flickering to glowing, you can obtain correct exposure. If you cannot obtain the indication of correct exposure by changing the aperture, reset the shutter speed.

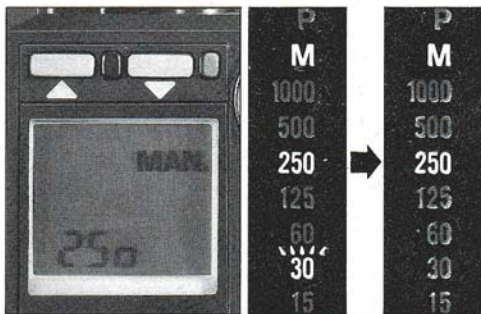

#### When determining aperture first

Set the aperture you desire. As you change the shutter-speed display changes the UP or DOWN button until the shutter-speed display changes from flickering to glowing, i.e., only the glowing speed remains, you can obtain correct exposure. If you cannot obtain the indication of correct exposure, no matter how you change the shutter speed, reset the aperture.

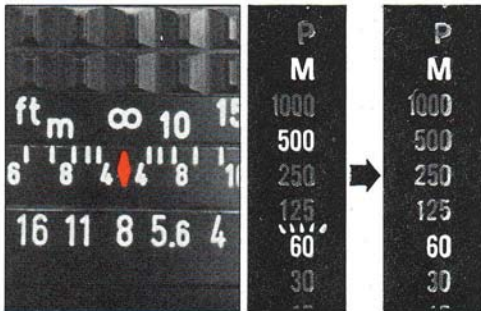

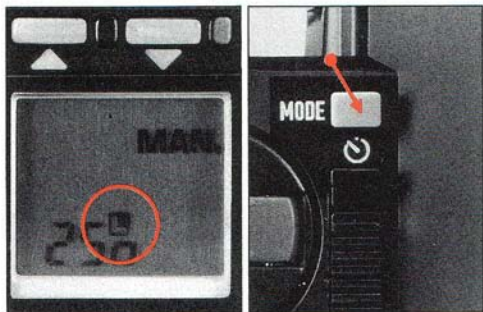

### Manual-shutter-speed lock

As you depress the mode button once after setting the shutter speed, the LCD window displays , locking the shutter speed so that it does not change even if you accidentally depress the UP or DOWN button.

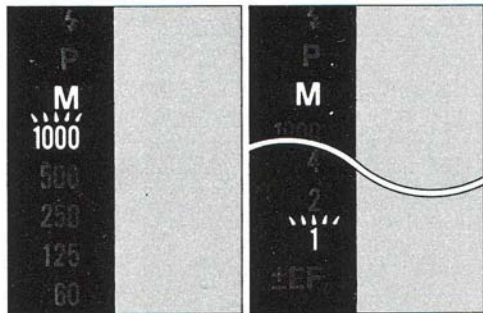

When the subject is too bright or too dark, "1000" or "1" flickers in the viewfinder as a warning. Change the shutter speed or the aperture so that you can obtain correct exposure. When the subject is so dark that the shutter speed of "30" or slower is displayed, there is a danger of camera shake and the use of the tripod or flash is recommended.

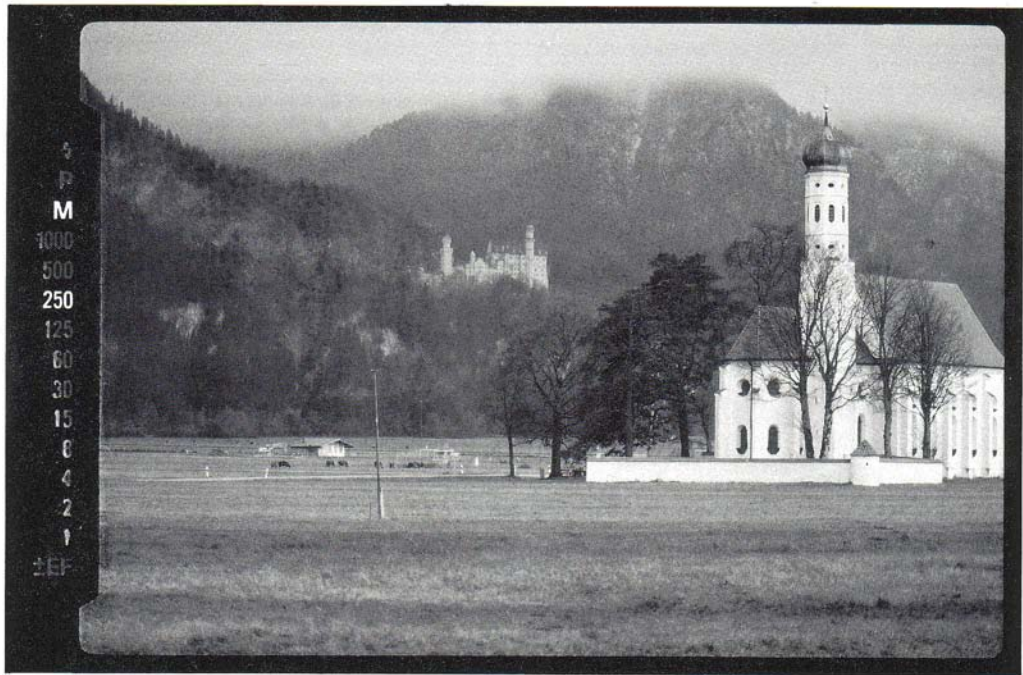

## WARNING DISPLAYS IN VIEWFINDER

Shutter speed	Remarks
P 1000	This display indicates the brightness of the subject is beyond the metering range in the Programmed AE mode. Releasing the shutter will result in incorrect exposure.
P 1	
1000	Indicates the brightness of the subject is beyond the metering range, or that the combination of shutter speed and aperture is beyond the coupling range, both in Metered Manual mode. In the latter case, you can change the aperture to obtain correct exposure. In the former case, the flickering does not disappear even if you change the aperture. Releasing the shutter with this display appearing will result in incorrect exposure.
1	
M 500	Indicates the brightness of the subject is beyond the correct-exposure range in the Metered Manual mode. Change the shutter speed and aperture, and when the flickering disappears and only one speed remains lit, you are ready to shoot.
M 125	
M 250	Indicates the brightness of the subject is beyond the metering range in the Metered Manual mode. The flickering does not disappear even if you change the shutter speed and aperture. Releasing the shutter will result in incorrect exposure.
M 60	
M 1000	Indicates the brightness of the subject is beyond the metering range in the Metered Manual mode. The flickering does not disappear even if you change the shutter speed and aperture. Releasing the shutter will result in incorrect exposure.
M 1	
P 125	When the exposure-memory lock is used, these LEDs flicker at a fast speed.
P 250	When batteries become exhausted, these LEDs flicker at a slow speed of once per second.
M 250	



- All these warnings are displayed by the flickering of LEDs in the viewfinder.
- “Beyond the metering range” means the subject is too bright or too dark to be measured with the camera’s built-in meter.
- “Beyond the coupling range” means the combination of shutter speed and aperture is beyond the limit of use even when the subject’s brightness is within the metered range.
- For details on the metering/coupling ranges, refer to page 56.
- The symbol  in the table indicates flickering. When the warning indicates beyond-the-metering-range/beyond-the-coupling-range, the shutter speed flickers as fast as four times per second.

**When the brightness of the subject is beyond the metering range, take pictures in the following ways:**

- When the subject is too bright, use an ND filter locally available.
- When the subject is too dark, it is necessary to use a flash or some other lightings.

## USING PENTAX DEDICATED AUTO FLASH UNITS

Using the AF200SA, AF240Z, or AF160SA flash unit with this camera easily allows the Programmed Auto Flash photography with the camera set to the Programmed AE mode. You just turn the flash's switch to ON. Furthermore, the AF200T, AF280T and AF400T can also be used with this camera in the Programmed Auto Flash mode. The table indicates what dedicated functions work when the camera is used with Pentax dedicated auto flash units.

- If the AF200T, AF280T or AF400T is used with the camera in the TTL Auto Flash mode the dedicated functions are indicated in the viewfinder, but the flash emits the full light output, resulting in incorrect exposure.
- The AF200SA, AF240Z and AF160SA do not provide the dedicated function described in 3.
- AF080C, AF200S, AF160S and earlier Pentax flashes apply to 1 and 2 only in the table, when the camera is used in the Aperture-Priority or Metered Manual mode.
- When the Pentax dedicated auto flash is used in its M or MS mode, the dedicated functions in the Programmed AE mode do not work.



Dedicated Functions (In Programmed Auto Flash mode)	
1	Flash-ready indication by the lighting of ⚡ mark.
2	As soon as flash is ready, shutter speed is automatically set to 1/100 sec. for flash sync.
3	When flash has worked properly, ⚡ mark in viewfinder disappears for an instant and lights up again or flickers, indicating that proper flash sync has been made.
4	In Programmed AE mode, aperture is also set automatically.

## USING PROGRAMMED AUTO FLASH MODE

Pentax dedicated flashes can be used with this camera, regardless of whether it is set to the Programmed AE or Metered Manual mode.

1. Attach the flash to the camera.
2. Set the flash mode selector to AUTO (red, green or yellow). This does not apply to the AF200SA, AF240Z and AF160SA.
3. Turn the flash switch on.
4. When the flash is ready, it is indicated by the glowing of  $\downarrow$  mark in the viewfinder. (When the meter's timer switch is off, the  $\downarrow$  mark also disappears.)



### Using in Programmed AE mode

- AF200SA, AF200T, AF280T and AF400T are compatible with this mode.
- As soon as the flash is ready, the camera is automatically switched to work at the flash sync speed of 1/100. The aperture is also automatically set to the programmed f-stop as shown in the table, depending on which AUTO position you choose.

(At ISO 100)

	AF200T	AF280T	AF400T
Red	f/2.8	f/4	f/4
Green	f/5.6	f/8	f/8
Yellow	—	—	f/11

(AF200SA: f/4 at ISO 100)

- As the film speed changes, the aperture also changes automatically.
- As shown in the above table, the aperture is set to f/2.8 when the AF200T is used in the Red AUTO, and therefore, using a lens whose maximum aperture is as small as f/4, for instance, will result in underexposure.

### Using in Aperture-Priority AE or Metered Manual mode

- Set the lens aperture to the f-stop indicated by the exposure table on the back of the flash.
- As soon as the flash is ready, the camera is automatically switched to work at 1/100 sec. flash sync speed. (In Metered Manual mode, the slow-speed sync described later is workable.)

### Auto Flash Check Mark (⚡)

When a proper flash photo has been taken, the ⚡ mark in the viewfinder disappears for an instant just after the flash firing and lights up again or blinks, indicating the completion of a proper flash photography. The AF200SA, AF240Z and AF160SA do not have this Auto Flash Check function.

### Slow-Speed Sync Photography

As you set the shutter speed between 1/60 and 1 sec. with the camera set in the Metered Manual mode, you can take a slow-speed-sync photo. As soon as the flash is ready, "⚡" and "M" marks plus the shutter speed set are displayed in the viewfinder.

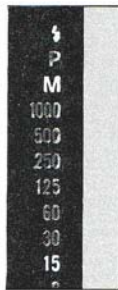

- When the shutter speed is set between 1/1000 and 1/125 sec., the camera is automatically switched to the flash sync speed of 1/100 sec., as soon as the flash is fully charged. (In this case, no shutter speed is displayed in the viewfinder.)

# ADVANCED OPERATIONS

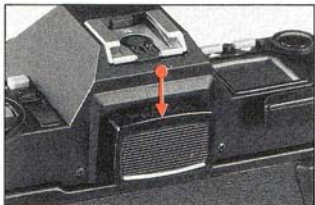

The self-timer is helpful for getting yourself into the photograph.

It can be set by sliding the main switch forward until the "S.T." is visible, while depressing the self-timer lever.

As you check the film wind lever and press the shutter release button, the shutter will be released about 12 seconds later. The self-timer lamp blinks to show the self-timer is working. About two seconds before shutter release, the lamp will start to blink at a faster rate. The self-timer can be cancelled even after it has started, by sliding the main switch back to the original position.

- When you shoot at the B (Bulb) setting, the self-timer cannot be used.

**Caution:** When using the self-timer, you keep your eye away from the viewfinder, and light entering through the eyepiece can cause errors in exposure. This can be prevented by sliding an accessory viewfinder cap over the eyepiece, to shield the metering system from extraneous light

## USING 100 (1/100 sec.)

When using a general, clip-on type flash on this camera, the camera must be set to 100 (1/100 sec.). Although this 1/100 sec. setting can be used for an ordinary picture taking purpose, you cannot confirm correct exposure through the viewfinder.

**Caution:** Do not use the non-Pentax-brand flashes whose dedicated functions also work with other cameras, because they may cause malfunctions or damage the electronic mechanisms of this camera.

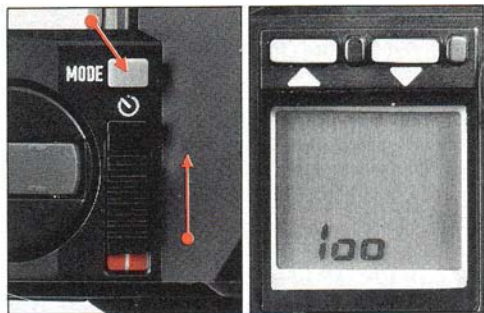

Set the lens aperture to an f-stop other than A. Set the main switch to ON. Display "100" in the LCD window by depressing the UP or DOWN button while pushing the mode button. As you depress the shutter button halfway, "M" appears in the viewfinder.

- When using a general clip-on type flash, select the proper f-stop according to the camera-to-subject distance or the programmed f-stop of the flash. (Refer to the flash's operating manual).
- When using a sync-cord-type flash, use the optional Hot-shoe Adapter 2P.

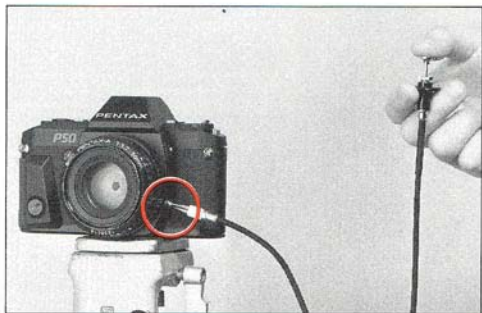
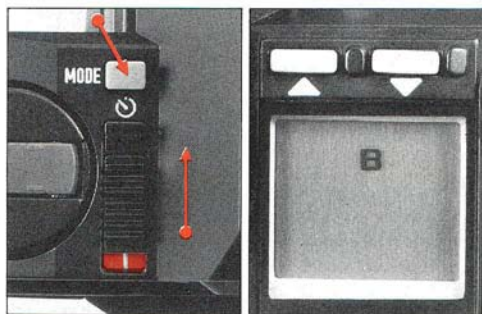

This setting is used to make long-time exposure to shoot night scenes, fireworks, etc. As long as you keep the shutter button depressed, the shutter stays open.

- Set the lens aperture to an f-stop other than A. Turn the main switch on. Display "B" in the LCD window by pushing the DOWN button while pushing the mode button.
- The long-time exposure consumes a great amount of battery power; fresh batteries will be exhausted in about 10 hours at normal temperatures.
- When shooting at B, use a sturdy tripod, and as shown in the photo, also use the optional Cable Switch A or Cable Release 50.
- Be sure to use the Cable Release 50 without twisting or bending it; otherwise it may not function properly. Always push the head of the Release strongly enough to release the shutter. Do not use the Cable Release 30.



## INFRARED INDEX MARK

If you intend to take infrared photographs using infrared film and R2 or O2 filters, it is necessary to compensate for the difference between visible light focus and infrared focus. As shown on the left, note the subject-to-camera distance on the lens distance scale as you focus through the viewfinder and turn the focusing ring until that distance setting aligns with the red infrared index mark. The figure shows an example in which the subject-to-camera distance is set at infinity ( $\infty$ ). As for exposure control required in infrared photography, refer to the film's instruction manual.

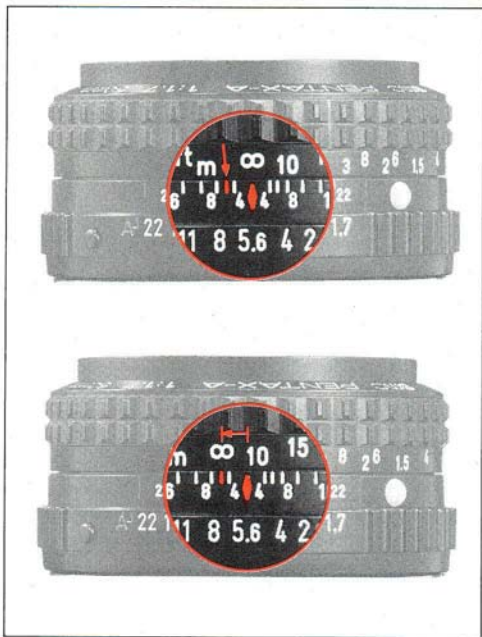



The exposure-memory lock enables you to take an exposure reading in the Programmed AE or Aperture-Priority AE mode, lock-in that reading, move your position, and then take the picture with the programmed reading. This is particularly useful in high-contrast conditions, such as when your subject is back-lit or has a dark background.



1. If you are taking a portrait, you can move in close to your subject and take a close-up reading of the face. To hold that reading, depress the memory-lock button; this will hold the reading for about ten seconds, simultaneously making the shutter speed (LED) you are using flicker in the viewfinder at a faster speed.



2. As long as you keep depressing the shutter button halfway while the memory lock is in use, the memory lock will be maintained or, in other words, the exposure will remain the same.

- When you wish to interrupt the memory lock, just turn the main switch off.

3. Recompose your picture and shoot; the subject will correctly be exposed. The memory lock will automatically be cancelled as soon as you release the shutter.

#### Cautions

- When the Pentax dedicated auto flash is used on this camera, the memory lock does not work.
- If you accidentally depress the memory-lock button with the camera in the Metered Manual mode, the shutter speed set will meaninglessly lock and flicker in the viewfinder.



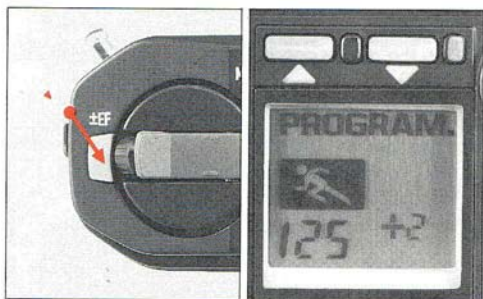

Examples of Subjects	Degrees of Compensation
<ul style="list-style-type: none"> <li>● Back-lit subjects</li> <li>● Landscapes with a large amount of the sky</li> </ul>	Approx. +1 ~ +2.5
<ul style="list-style-type: none"> <li>● Person(s) on the snow</li> <li>● Person(s) with the sky in background</li> </ul>	Approx. +1.5 ~ 2
<ul style="list-style-type: none"> <li>● Subjects with dark background</li> <li>● Stage</li> </ul>	Approx. -1 ~ -2.5

The exposure compensation is made when you intentionally wish to overexpose or underexpose your picture, depending on the condition of the subject, in Programmed AE or Aperture-Priority AE mode.

To make the exposure compensation, push the UP or DOWN button, step by step, while keeping the exposure-compensation button ( $\pm EF$ ) depressed, until the compensation value desired is set. The range from +3 to -3 can be adjusted by every 0.5 step.

While the exposure compensation is taking place, the compensation value flickers in the LCD window, and as you depress the shutter button halfway, " $\pm EF$ " flickers in the viewfinder. Be sure to return the value to 0 when the compensation is over.

In the Metered Manual mode, it is advisable to change the aperture or the shutter speed after correct exposure is displayed.

▲ UP button	←	→	▼ DOWN button
+3	~	0	~ -3
(● Displayed by every 0.5 step)			

0



+1



0



-1



## DEPTH OF FIELD

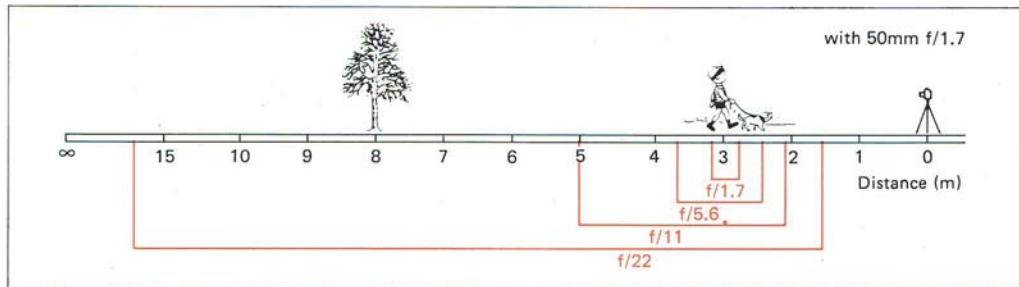

Depth-of-field is the range between the nearest and farthest distances which are in focus at a given lens aperture.

The minimum aperture (for example f/22) gives you the greatest depth-of-field, or area in focus.

The maximum aperture (for example f/1.7) gives you the smallest depth-of-field. When you vary aperture value, the range "in focus" changes accordingly, so that you can create different photographic effects in your pictures. As illustrated in the pictures on the right (examples of f/1.7 and f/22), the distance range in focus can be confirmed by the depth-of-field scale on the lens.



f/1.7 (2.82 ~ 3.2m)

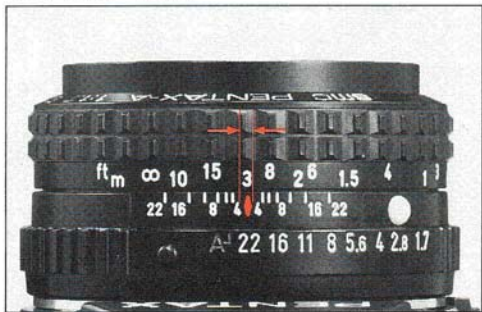

f/22 (1.67 ~ 16.9m)





Your camera enables you to preview just what will and what will not be sharp in your pictures. By depressing the preview lever near the lens mount, you can close the lens down to whatever aperture you have set. You can then preview how much sharpness you will get in your picture by examining the picture area on the ground glass. After previewing your picture, if you release the preview lever, the lens will return to full aperture for focusing. You cannot, however, preview the depth of field with your camera set in the Programmed AE mode.

**Note:** Taking pictures with the preview lever depressed will result in incorrectly exposed pictures.

Depth-of-field Table: SMC Pentax-A 50mm Lens

unit=meter

Distance scale	f/1.4	f/2	f/2.8	f/4	f/5.6	f/8	f/11	f/16	f/22
0.45m	~ 0.448 0.453	~ 0.446 0.454	~ 0.445 0.455	~ 0.443 0.457	~ 0.440 0.460	~ 0.436 0.465	~ 0.431 0.471	~ 0.423 0.481	~ 0.414 0.493
0.5m	~ 0.497 0.503	~ 0.495 0.505	~ 0.494 0.507	~ 0.491 0.509	~ 0.487 0.513	~ 0.482 0.519	~ 0.476 0.527	~ 0.466 0.540	~ 0.454 0.557
0.6m	~ 0.595 0.605	~ 0.593 0.607	~ 0.590 0.610	~ 0.586 0.615	~ 0.581 0.621	~ 0.573 0.630	~ 0.564 0.642	~ 0.549 0.663	~ 0.532 0.691
0.8m	~ 0.791 0.810	~ 0.787 0.814	~ 0.781 0.820	~ 0.774 0.828	~ 0.764 0.840	~ 0.749 0.859	~ 0.732 0.883	~ 0.705 0.927	~ 0.675 0.987
1.0m	~ 0.985 1.016	~ 0.978 1.023	~ 0.970 1.032	~ 0.958 1.046	~ 0.942 1.066	~ 0.919 1.098	~ 0.892 1.140	~ 0.851 1.218	~ 0.806 1.328
1.5m	~ 1.464 1.538	~ 1.449 1.555	~ 1.430 1.578	~ 1.402 1.613	~ 1.366 1.664	~ 1.316 1.746	~ 1.259 1.861	~ 1.174 2.093	~ 1.086 2.462
2.0m	~ 1.935 2.070	~ 1.908 2.101	~ 1.874 2.144	~ 1.825 2.213	~ 1.764 2.312	~ 1.679 2.478	~ 1.584 2.724	~ 1.449 3.265	~ 1.314 4.298
3.0m	~ 2.853 3.164	~ 2.794 3.239	~ 2.719 3.346	~ 2.615 3.521	~ 2.487 3.785	~ 2.318 4.265	~ 2.137 5.073	~ 1.892 7.426	~ 1.665 16.883
10.0m	~ 8.488 12.171	~ 7.973 13.421	~ 7.375 15.552	~ 6.631 20.422	~ 5.846 35.101	~ 4.966	~ 4.181	~ 3.313	~ 2.655
∞	~ 55.370 ∞	~ 38.772 ∞	~ 27.707 ∞	~ 19.408 ∞	~ 13.876 ∞	~ 9.726	~ 7.086	~ 4.885	~ 3.565





# PROGRAMMED AE DIAGRAM, METERING RANGE AND SHUTTER/APERTURE COUPLING RANGE

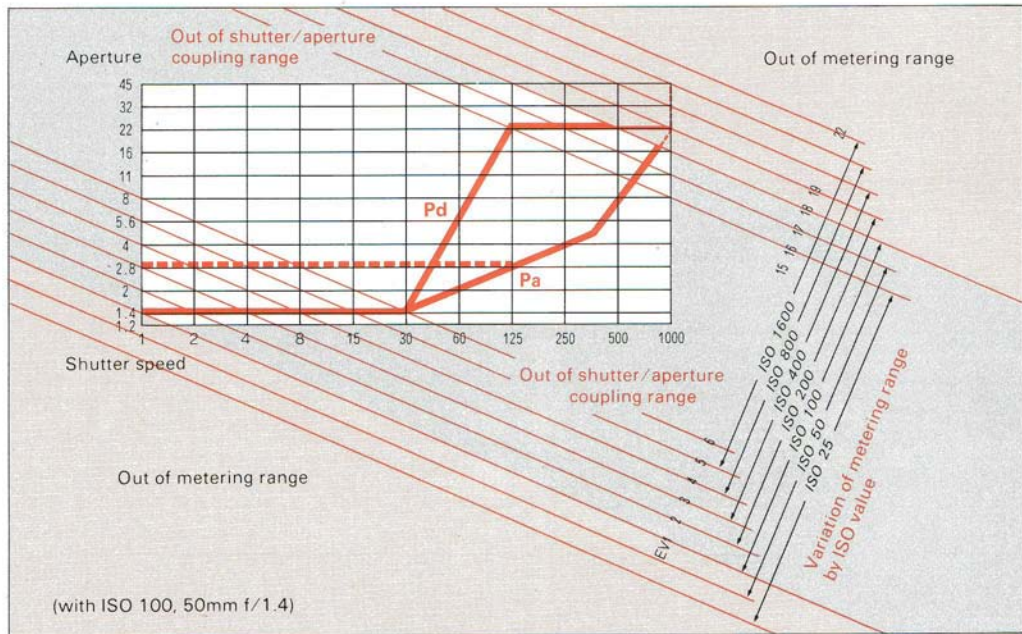

### **Programmed-AE diagram**

The chart at left illustrates the combination of shutter speeds and apertures in the Programmed AE mode. The thick lines represent how the combination varies when the 50mm f/1.4 lens and ISO 100 film are used.

As the "Pa" line indicates, the Program Action mode is programmed to provide faster shutter speeds, while the Program Depth mode, as the "Pd" line indicates, is programmed to make the depth of field greater. When using the lens with a different maximum aperture, the combination of shutter speed and aperture changes until the aperture reaches its maximum.

When an f/2.8 lens is used, the shutter-speed/aperture combination varies as indicated by the red-dotted line.

The thin red-dotted line shows how the combination changes when the lens with different maximum and minimum apertures is used, or when the film speed (ISO) is changed. As the aperture range (f/1.4 - f/22) changes, the limit of the metering range changes.

### **Metering Range and Shutter/Aperture Coupling Range**

The metering range means the range of subject luminance within which the built-in exposure-meter works to control exposure. The shutter/aperture coupling range is that part of the metering range within which shutter-speed and aperture value can be combined for proper exposure control. When you use a 50mm f/1.4 normal lens and an ISO 100 film, the metering range is from EV 1 (f/1.4-1 sec.) to EV 18 (f/16-1/1000 sec. or f/22-1/500 sec.). The range varies according to film speed (ISO). The variation of the metering range is shown by slanting lines which shift ISO ratings. The frame in the center shows the meter and shutter/aperture control coupling range.

### **EV (Exposure Value)**

EV represents a combination of the shutter-speed and the lens aperture which is determined by the film speed (ISO) and the brightness of the subject.

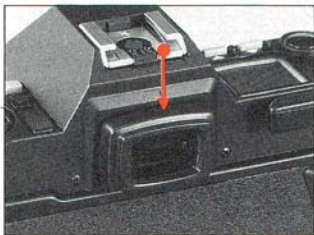

Diopter correction lenses M which fit the eyepiece on your camera are available. If you find it difficult to see the viewfinder image clearly, choose any one of the eight Correction Lenses M of  $-5$ ,  $-4$ ,  $-3$ ,  $-2$ ,  $-1$ ,  $+1$ ,  $+2$ ,  $+3$  diopters. Slide it into the eyepiece's accessory groove. Before buying one, try it for yourself with the lens attached to your camera.



### Mount Adapter K





If you want to use any conventional Takumar screw-mount lens on your camera it is possible by placing an optional accessory called the Mount Adapter K between the camera body and the lens. However, please note the following conditions when actually taking pictures:

- Automatic diaphragm does not work due to difference in the coupling system.
- Stop-down metering must be made.
- Automatic aperture setting with a Pentax dedicated flash is not workable.

## PRECAUTIONS ON BATTERIES

- Incorrect usage of batteries causes such hazards as leakage, heating or explosions. Polarity markings should be carefully checked while inserting batteries. If either battery is erroneously inserted, unexpected mishap may occur.
- Replace both batteries at the same time. Do not mix battery brands and types, or old batteries with new batteries.
- When not using the camera for long periods of time, you should remove batteries from the camera. Old batteries are apt to leak and damage the battery compartment. Always keep batteries out of the reach of children.
- Never break, recharge, or throw used batteries into fire as a precaution against explosions.
- Batteries should be kept warm in cold climates to prevent lowering of performance.
- Keep spare batteries on hand for convenience in photographing outdoors or while traveling, etc.
- One set of alkaline batteries should last about six months and one set of silver-oxide batteries about a year, both with average use.
- When keeping the camera in a bag or case, be sure to turn the main switch off to avoid the unnecessary consumption of battery power that may result from accidentally releasing the shutter.

## SPECIFICATIONS

<b>Type:</b>	35mm SLR with Dual-Program AE mode and TTL metering.
<b>Film:</b>	35mm perforated cartridge film. 24 x 36mm format.
<b>Lens mount:</b>	Pentax KA mount.
<b>Exposure modes:</b>	Dual-Program AE (Program Action & Program Depth), Aperture-Priority AE, Metered Manual and Programmed Auto Flash.
<b>Shutter:</b>	Vertical-run, focal-plane shutter. Electronically-controlled auto shutter speeds from 1/1000 to 1 sec. and manual shutter speeds from 1/1000 to 1 sec. plus B (Bulb). Electro-magnetic shutter release.
<b>Viewfinder:</b>	Silver-coated pentaprism finder with split-image/large microprism/clear-bright-matte focusing screen. 92% picture area at 0.82X magnification with 50mm lens at infinity. -1 diopter eyepiece.
<b>Viewfinder displays:</b>	LED displays for "S" (flash ready), "P" (Programmed AE mode), "M" (Metered Manual), 11 shutter speeds (green LEDs for 1000 ~ 60; orange ones for 30 ~ 1), "±EF" (exposure compensation) and beyond-coupling-range warning (1000 or 1 LED flickers at 4Hz).
<b>LCD window displays:</b>	PROGRAM for Programmed AE mode (  for Program Action and  for Program Depth), AUTO for Aperture-Priority, MAN. for Metered Manual, "  " for manual shutter lock, shutter speeds from 1000 to 1, +3 ~ -3 exposure compensation, "  " for shutter-cocked indication, and "B" for Bulb.
<b>Flash synchronization:</b>	X-contact hot shoe. X-sync at 1/100 sec.
<b>Self-timer:</b>	Electronically-controlled 12-sec. delay timer with LED indicator and interrupt function.
<b>Mirror:</b>	Swing-back, instant-return type.
<b>Film loading:</b>	Easy loading. Film-information window on back cover.
<b>Film transport:</b>	Single-stroke, rapid-wind lever with 130° throw and 35° stand-off angles. Winder ME-II and Motor Drive A usable.

<b>Film-speed setting:</b>	Automatic setting from ISO 25 to 1600 with DX-coded film.
<b>Film rewind:</b>	Rewind crank.
<b>Exposure counter:</b>	Mechanical additive type with auto resetting mechanism.
<b>Exposure metering:</b>	TTL center-weighted, open-aperture, full-area metering system with GPD cell.
<b>Metering range:</b>	EV 1 (f/1.4, 1 sec.) to EV 18 (f/16, 1/1000 sec.) at ISO 100 with 50mm f/1.4 lens.
<b>Exposure compensation:</b>	Via exposure-compensation button for compensation from +3 to -3.
<b>Exposure-memory lock:</b>	Via exposure-memory-lock button.
<b>Depth-of-field preview:</b>	Via preview lever.
<b>Power source:</b>	Two 1.5V alkaline or silver-oxide mini batteries.
<b>Size &amp; weight:</b>	137(W) x 87.5(H) x 50.5(D)mm (5.3" x 3.4" x 2.0"); 525 g (18.4 oz.) without batteries.
<b>Accessories:</b>	Grip, Strap A and Viewfinder Cap.

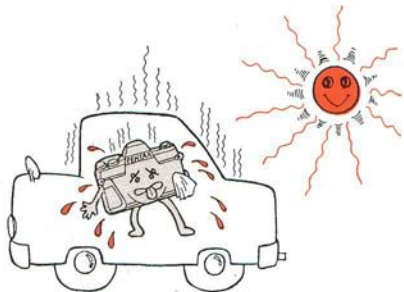

Your Pentax camera is a sophisticated, precision instrument built to give long-lasting, reliable service. It will serve you well if you treat it right, with proper handling and reasonable care. The major causes of damage are:

1. Dropping or banging the camera against immovable objects, which can damage the camera in many ways.
2. Water damage, particularly if the camera is submerged in salt water. Cameras are not waterproof! They must be protected from salt breeze, salt spray at the beach, splashing of any kind, and shielded from the rain. If your camera does get soaked, wipe it dry immediately and rush it to a Pentax service center.
3. Dirt and sand can cause serious damage to the shutter and other moving parts of the camera. Your camera needs periodic cleaning to keep it operating properly. To remove dirt and dust, you need lens-cleaning fluid, lens-cleaning tissues, bulb-type ear syringe, camel's hair brush, etc. Never use a solvent such as thinner or alcohol.



4. Humidity and temperature extremes should be avoided. Keep your camera out of direct sunlight, car trunks, and glove compartments. Shooting outdoors in winter presents a problem since batteries won't function if they get too cold. In cold weather carry your camera under your coat or jacket to keep the batteries warm. The temperatures at which this camera should function properly are approx.  $50^{\circ} \sim -10^{\circ} \text{C}$ . Sudden changes in temperature will often cause moisture to condense inside or outside your camera. This is a possible source of rust, which may be extremely harmful to the mechanism. Furthermore, if the camera is taken from a warm temperature to a sub-freezing one, further damage may result from the formation of icelets. Thus, sudden temperature changes should be avoided as much as possible. As a guide, a temperature change of  $10^{\circ} \text{C}$  should be allowed to take place gradually over a period of at least 30 minutes. If this is not possible, keeping the camera in its case or bag will help somewhat in minimizing the effects of a rapid temperature change.
5. Vibration experienced when you are traveling in a car, plane, or ship, can cause screws to loosen. To minimize this problem use foam-rubber padding about one inch thick to line the bottom of your camera bag.
6. When mounting your camera on a tripod, make sure the tripod screw is no longer than 5.5mm, which is the depth of your camera's tripod socket. If you use a longer screw, you will possibly puncture the tripod socket, after which the camera will not function properly.

All Pentax cameras purchased through authorized bona fide photographic distribution channels are guaranteed against defects of material or workmanship for a period of twelve months from date of purchase. Service will be rendered and defective parts will be replaced without cost to you within that period, provided the equipment does not show evidence of impact, sand or liquid damage, mishandling, tampering, battery or chemical corrosion, operation contrary to operating instructions, or modification by an unauthorized repair shop. Because the tolerances, quality, and design compatibility of lenses other than Pentax lenses are beyond our control, damage caused by use of such lenses will not be covered by this warranty policy. The manufacturer or its authorized representatives shall not be liable for any repair or alterations except those made with its written consent and shall not be liable for damages from delay or loss of use or from other indirect or consequential damages of any kind, whether caused by defective material or workmanship or otherwise; and it is expressly agreed that the liability of the manufacturer or its representatives under all guarantees or warranties, whether expressed or implied, is strictly limited

to the replacement of parts as hereinbefore provided. No refunds will be made on repairs performed by non-authorized Pentax service facilities.

### **Procedure During 12-month Warranty Period**

Any Pentax which proves defective during the 12-month warranty period should be returned to the dealer from whom you purchased the equipment or to the manufacturer. If there is no representative of the manufacturer in your country, send the equipment to the manufacturer, with postage prepaid. In this case, it will take a considerable length of time before the equipment can be returned to you owing to the complicated customs procedures required in Japan in importing and re-exporting photographic equipment. If the equipment is covered by warranty, repairs will be made and parts replaced free of charge, and the equipment will be returned to you upon completion of servicing. If the equipment is not covered by warranty, regular charges of the manufacturer or of its representatives will apply. Shipping charges are to be borne by the owner. If your Pentax was purchased outside of the country where you wish

to have serviced during the warranty period, regular handling and servicing fees may be charged by the manufacturer's representatives in that country. Notwithstanding this, your Pentax returned to the manufacturer will be serviced free of charge according to this procedure and warranty policy. In any case, however, shipping charges and customs clearance fees are to be borne by the sender. To prove the date of your purchase when required, please keep the receipts or bills covering the purchase of your equipment for at least a year. Before sending your equipment for servicing, please make sure that you are sending it to the manufacturer's authorized representatives or their accredited repair shops, unless you are sending it directly to the manufacturer. Always obtain a quotation of the service charge, and only after you accept the quoted service charge, instruct the service station to proceed with the servicing.

**This warranty policy does not apply to Pentax products purchased in the U.S.A., U.K., or Canada. The local warranty policies available from Pentax distributors in those countries supersede this warranty policy.**



Asahi Optical Co., Ltd. C.P.O. 895, Tokyo 100-91, JAPAN  
Pentax Europe n.v. Weiveldlaan 3-5, 1930 Zaventem Zuid-7, BELGIUM  
Pentax Handelsgesellschaft mbH Postfach 54 0169, 2000 Hamburg 54, WEST GERMANY  
Pentax U.K. Limited Pentax House, South Hill Avenue, South Harrow, Middlesex HA2 0LT, U.K.  
Pentax France S.A. Z.I. Argenteuil, 12, Rue Ambroise-Croizat, 95100 Argenteuil, FRANCE  
Pentax (Schweiz) AG Industriestrasse 2, 8305 Dietlikon ZH, SWITZERLAND  
Pentax Svenska AB Box 650, S-751 27 Uppsala, SWEDEN  
Pentax Nederland Spinveld 25, 4815 HR Breda, THE NETHERLANDS  
Pentax Norge A/S Stenersgt. 18, Oslo 1, NORWAY  
Pentax Corporation 35 Inverness Drive East, Englewood, Colorado 80112, U.S.A.  
Pentax Canada Inc. 1760 West 3rd Avenue, Vancouver, B.C. V6J 1K5, CANADA  
Asahi Optical Brasileira Ind. e Com. Ltda. Rua Capitão Antonio Rosa 376, Sala 121 Ed. PBK, São Paulo, BRASIL