

PENTAX[®]

P30



Thank you most sincerely for choosing one of our Pentax 35mm SLR cameras.

Before starting to operate this camera, please be sure to read this operating manual very carefully to familiarize yourself with every detail of the features and functions it has to offer. We hope you will enjoy fine photography with this camera for many years to come.



TABLE OF CONTENTS

Features	2	ADVANCED OPERATION	
Nomenclature of working parts	4	Exposure-memory lock	32
PREPARATIONS		Self-timer	33
Inserting batteries	7	Using 100 $\frac{1}{2}$ setting	34
Attaching and detaching lens	9	Using B (Bulb) setting	35
Film wind lever	10	Depth of field	36
Main switch, shutter release button, shutter dial	11	Depth-of-field preview	38
Film	12	Infrared index mark	39
Loading film	13	Programmed AE diagram, metering range and shutter/aperture coupling range	40
Unloading film	16	Diopter correction, mount adapter K	42
Strap and soft case	17	Precautions on batteries	43
BASIC OPERATION		Specifications	44
Viewfinder displays	19	Taking care of your camera	46
Focusing	20	Warranty policy	48
Holding camera	21		
Shooting in Programmed AE mode	22		
Shooting in Metered Manual mode	24		
Warning displays	27		
Using Pentax dedicated auto flash units	28		
Using Programmed Auto Flash mode	29		

When this camera is used with any SMC Pentax-A lens, it offers three exposure modes: Programmed AE, Metered Manual and Programmed Auto Flash. When the lens aperture is set to "A" position, the Programmed AE mode can be used. When the lens aperture is set to any f-stop other than the "A" setting, the Metered Manual mode can be used.

- When the conventional K- or Kf-mount lens is used, the camera operates in the Metered Manual mode.

Programmed AE Mode

The camera automatically selects the most suitable combination of shutter speed and aperture to obtain correct exposure, simultaneously changing the combination according to the brightness of the subject. This mode is suitable for those who do not want to be bothered by setting exposure controls or those wishing to take "action" photos.

Metered Manual Mode

The combination of shutter speed and aperture is completely up to you. Guided by the meter indication in the viewfinder, you can adjust both controls to obtain proper exposure. If necessary, deliberate over- or underexposure can be obtained.

Programmed Auto Flash Mode

When you use a Pentax dedicated auto flash on this camera in its Programmed AE mode, the camera automatically selects the proper aperture and shutter speed to control flash output for proper flash pictures.



What you should know first about this camera

- The camera does not operate unless the batteries are properly inserted. Be sure to check how they are inserted before operating it. Also check if the main meter switch is set to ON or OFF.
- Most flashes made by others can be used on this camera, but Pentax dedicated flashes will offer more convenient functions. Even if you use a flash with TTL auto flash provision, this camera does not provide TTL auto flash operation.
- When you use the accessories such as Extension Tubes, Auto Bellows, etc. that are mounted between the camera body and lens, this camera operates in the Metered Manual mode. The Programmed AE mode cannot be used.

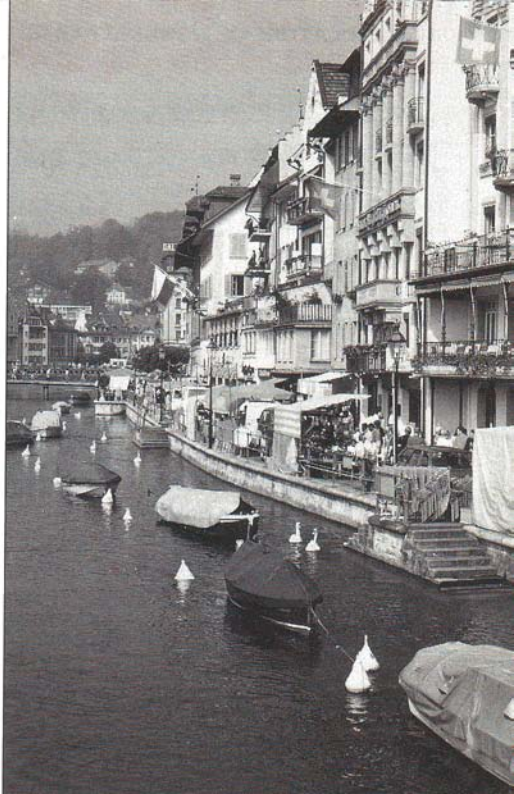

NOMENCLATURE OF WORKING PARTS

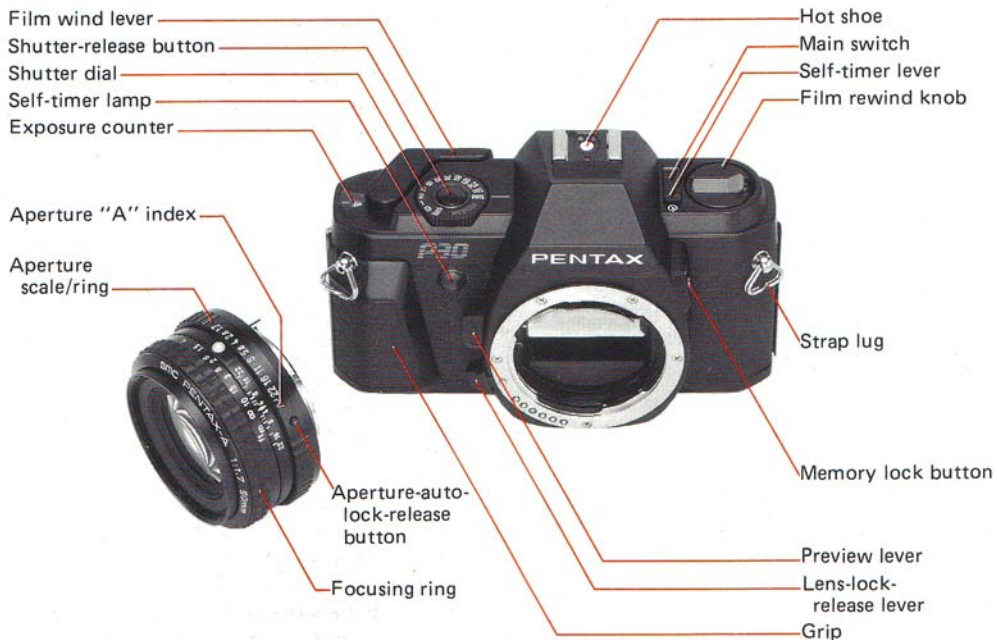

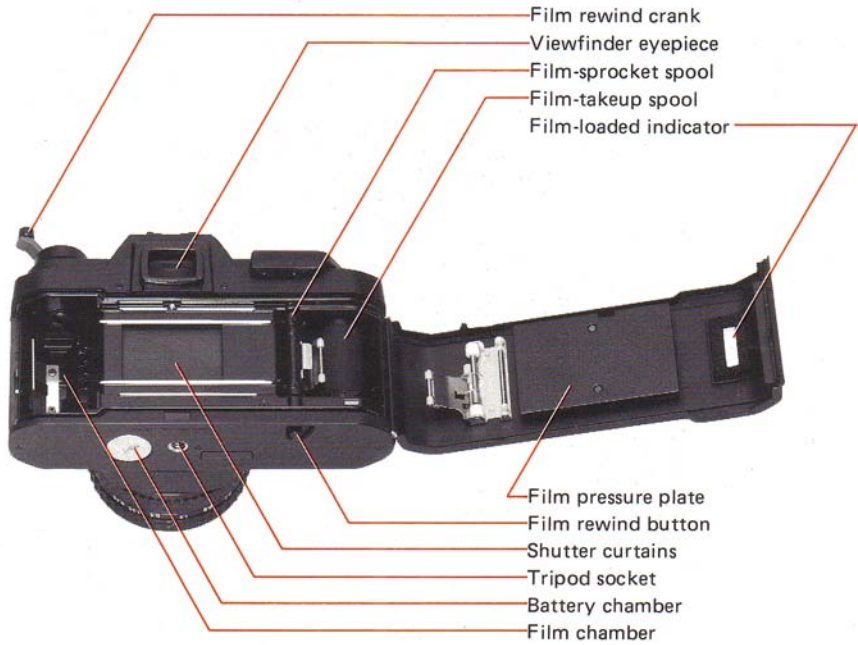

Film rewind crank

Viewfinder eyepiece

Film-sprocket spool

Film-takeup spool

Film-loaded indicator

Film pressure plate

Film rewind button

Shutter curtains

Tripod socket

Battery chamber

Film chamber



PREPARATIONS

INSERTING BATTERIES

This camera is powered by two alkaline or silver-oxide (AA-size, 1.5-V) batteries.

- Open the battery chamber cover by turning it counter-clockwise with a coin.
- Insert the two batteries into the chamber with their (+) sides facing downward, and replace the cover.
- As illustrated, turn the meter on by sliding the main switch in the direction of the arrow.

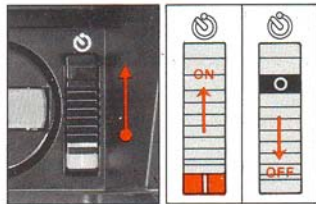
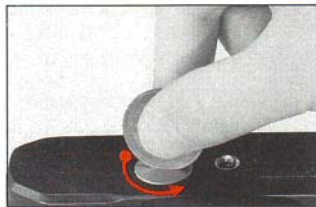

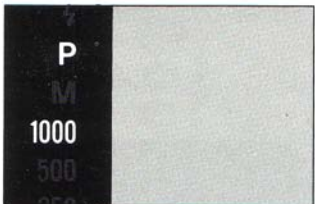

- Press the shutter release button half-way and make sure that a shutter speed appears on the left side of the viewfinder.

Timer switch

The built-in timer switch automatically turns the meter off in about ten seconds after you release your finger off the shutter button.

Battery check

If no shutter speed is displayed in the viewfinder even with a slight pressure on the shutter button, the batteries have no power or may be improperly inserted.

When batteries weaken

When the batteries are becoming weak, the shutter speed displayed in the viewfinder starts to blink slowly at the speed of once per second. If so, replace the batteries immediately. If the batteries are completely exhausted, the shutter button does not release the shutter.

ATTACHING AND DETACHING LENS

To mount or interchange Pentax K, KA and Kf mount lenses, follow the steps below.

- Remove the body mount cap and the rear lens cap. If the finder cap is still on the eyepiece, remove it.
 - Align the red dot on the camera body with the red dot on the lens (See **A**, **B**). Seat the lens in the body mount and turn it clockwise until the lens locks with a click. When mounting the lens in dim light, method (**C**) is recommended. This method allows lens mounting by touch.
- Align the raised node on lens barrel with the lens release by touch. Then turn and lock as above.
- To remove the lens cap, press in on the notches at both sides.
 - To remove the lens, press the lens release lever toward the camera body while turning the lens counter-clockwise.
 - After removing a lens from the camera body, replace the front and rear lens caps to protect the lens from dust and stains.

Note: Don't damage or stain the electrical contact points on the mount face. When they become stained, wipe them with a clean, dry cloth.

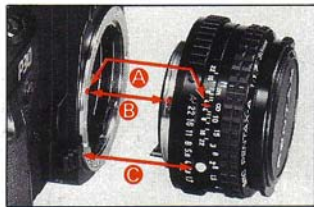

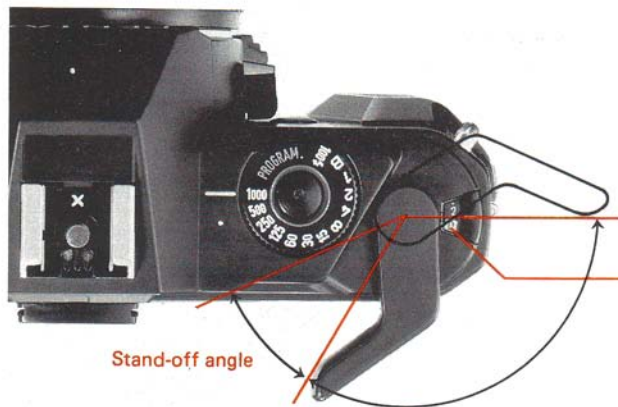

Stand-off angle

Exposure counter

The scale is indexed as follows:

S ● 0 ● 2 ● 4 ● ● 20 ●
24 ● ... ● 36.

Interlocked with the film wind mechanism, this counter indicates the number of exposed frames.

Setting the wind lever for rapid shooting

The film wind lever can be set at the stand-off position for faster film advance. Even if you remove your thumb from the lever, it remains at the stand-off angle, ready for the next quick shot. After completing a series of pictures, the lever should be pushed in to the original position.

Film advance stroke

The film wind lever should be thrown as far as it goes.

Note: The wind lever may stop in the middle of a stroke when the film comes to its end. Do not force the lever and rewind the film, leaving the lever as it is.

- **Main switch**

To release the shutter, be sure to turn the main switch to ON. When the main switch is off, the shutter cannot be released and the meter remains off.

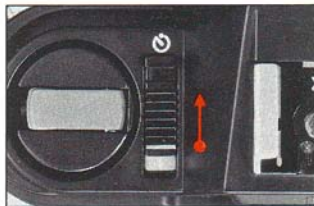

- **Shutter release button**

As you turn the main switch on and press the shutter release button half-way, the meter will turn on, and a further pressure on the shutter button will release the shutter.



- **Shutter speed dial**

When shooting in the Metered Manual mode, turn the shutter speed dial until the desired shutter speed aligns with the index (red line).

1000 – 1 = 1/1000 - 1 sec.

B = Bulb (long-time exposure)

100 $\frac{1}{2}$ = 1/100 sec. (flash-sync speed)



DX FILM

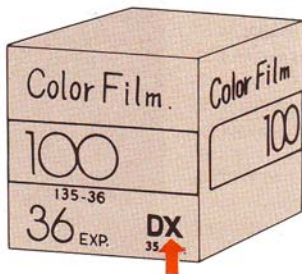

This camera automatically sets the ISO film speed of DX-coded film when it is loaded into the film chamber. Therefore, you are recommended to use only DX-coded film in this camera. (If non-DX film is loaded the camera will automatically set the film speed to 100, whatever film speed it may have; in other words, the only non-DX film usable for this camera is one with ISO 100.)

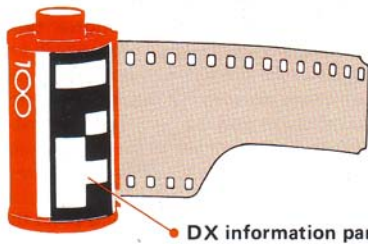

DX information panel

The film speeds which can be automatically set by this camera range from ISO 25 to 1600, so be sure to use the DX-coded film having a film speed within this range.

LOADING FILM



Always load or unload film in the camera in a shady spot, or shield it from direct sunlight with your body.

- As illustrated, unfold the rewind crank by pushing it with your finger-nail.
- Pull the rewind knob upwards until the back cover snaps open.
- Slide the film cartridge into the film chamber with the flat side up. Lock the cartridge in place by pushing the rewind knob down, rotating it slightly making sure that it grips the spool.

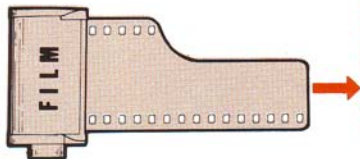

- | | |
|------------------|------------------------|
| 1 Film chamber | 4 Spool teeth |
| 2 Guide rails | 5 Film leader end mark |
| 3 Sprocket teeth | 6 DX-information pins |

Keep the DX-information pins free from scratches, dirt, dust, etc.

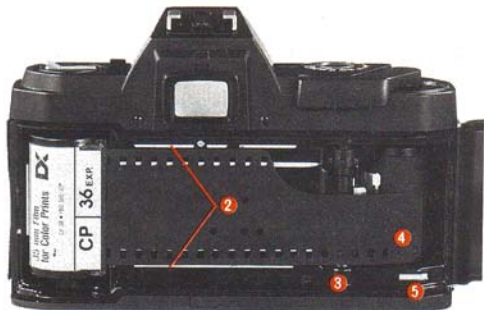

- As illustrated, pull the film leader out so that its end aligns with the 5 film leader end mark (red bar); in other words, bring the film leader end within the length of the bar.
- Make sure that the perforations on the bottom side of the film have engaged the 3 sprocket teeth as well as the 4 spool teeth.
- Also make sure that the film is properly placed between the two 2 guide rails.
- Take up any slack left in the film so that the film is flat as shown, by rewinding it slightly into the cartridge.
- When a film with a higher ISO number is loaded, do not leave the camera out of the case for a long time.

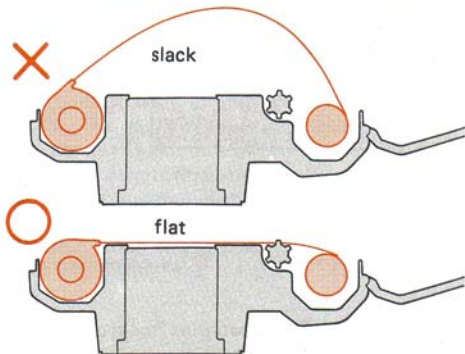

- Close the back cover, making sure that it has snapped firmly in place.



- Cock the film wind lever while checking to see if the film rewind knob turns in the direction of the arrow.



- Repeat making blank exposures until "0" appears in the exposure counter. The next frame is ready for the first shot.

- The film-loaded indicator on the back cover will tell you if the film is loaded or not.



UNLOADING FILM

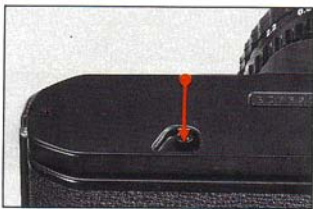

When you reach the end of the roll, the film wind lever will stop moving abruptly — maybe at some point in the middle of a stroke. Do not force the lever beyond the number of exposures shown on the cartridge.



- Press the film rewind button recessed in the base of the camera.
- Unfold the crank and turn it clockwise all the way until you feel it loosen when the film leader releases from the take-up spool.



- When the rewinding is over, lift the rewind knob sharply to open the back cover, and take the cartridge out.

If you accidentally opened the back cover without rewinding the film, close it immediately, since the film except the last several frames might be saved.

STRAP AND SOFT CASE

- To attach the strap to the camera, first pass the end of the strap through the strap lug on the camera, fold it back, then pass it through the strap ring, and through the strap clasp and the last ring. The strap end may be passed through the inside or outside of the clasp.
- Remove the front cover from the back cover. Put the camera in the back cover and put both case hooks around the camera's strap eyelets. The camera is now held securely in place.
- The soft case for this camera is available in two sizes: P3-S for the camera with a standard 50mm lens, and P3-L for the camera with a zoom lens such as 35 - 70mm.

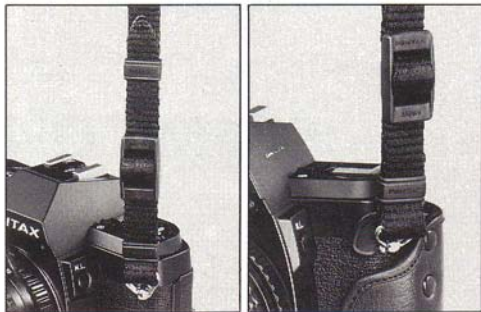

BASIC OPERATION

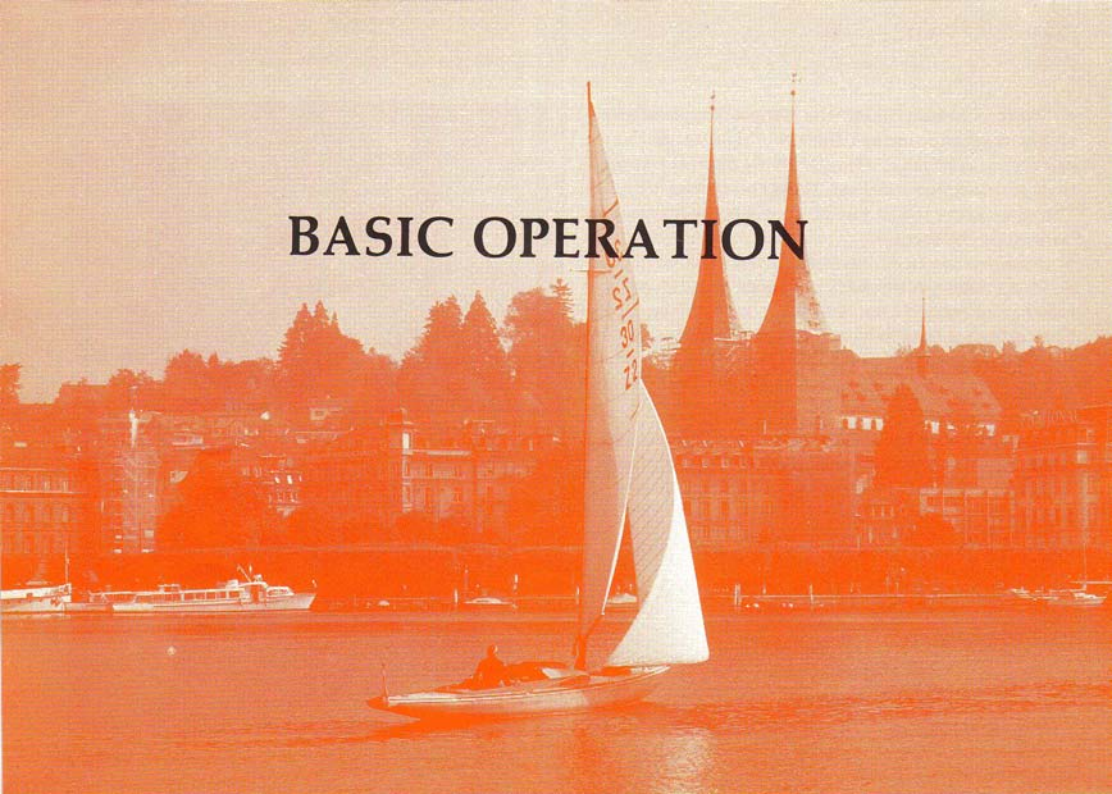

VIEWFINDER DISPLAYS

Various exposure data described at right are displayed by LED on the left side of the viewfinder.

LED = Light-Emitting Diode

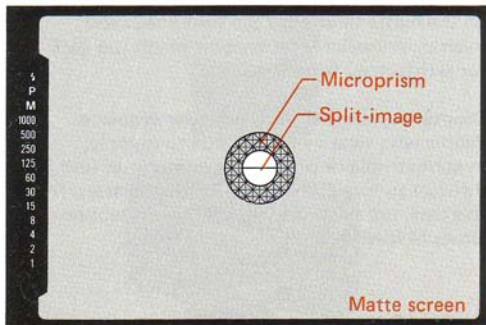

- P Programmed AE mode
- M Metered Manual mode
- 1000 ~ 1 Shutter speeds from 1/1000 to 1 sec.
- 1/2 Flash-ready indication
- Blinking "1000".... Overexposure indication (blinks eight times per second)
- Blinking "1"..... Underexposure indication (blinks eight times per second)

(Above two indications also appear when the exposure combination is out of the shutter/aperture-coupling range or the metering range.)

- Camera-shake (stow-shutter-speed) warning
- Warning 30 ~ 1 appears in yellow



You can focus in three ways, with the split-image, microprism, and/or matte field. To focus using the split-image, turn the focusing ring until the two images in the split-image circle at the center of the focusing screen are perfectly aligned. When using the microprism collar, focus until the glitter disappears from inside the collar. With the matte field, focus until the image on the matte field appears sharp and crisp.

Note: If the maximum aperture of the attached lens is smaller than $f/5.6$ (for example, $f/8$ as in the case of a long telephoto), it is easier to focus on the matte field since the split-image and microprism collar areas become much too dark for satisfactory focusing.

Diopter adjustment for viewfinder eyepiece
People who wear eyeglasses due to myopia, hypermetropia or presbyopia, sometimes find it difficult to focus while wearing their glasses. In this case, use the accessory diopter correction lenses M (See page 42).

HOLDING CAMERA

Proper holding of the camera is essential to minimize camera shake which causes blurred pictures. Practice holding and operating your camera before inserting your first film cartridge. Generally there are three basic ways to hold the camera. In any case, hold the camera tightly to your face with your hands. The grips on this camera will help you keep a steady hold on your camera. Release the shutter gently while slowly breathing out. Strong pressure on the shutter

release button may cause blurred photographs. Take a secure, well-balanced posture without straining yourself. The portion marked O in the illustration should be drawn to your body. It is a good idea to stabilize your body and the camera using a tree, building wall, table, etc. For long exposures or while using telephoto lenses, it is recommended to use a tripod in order to reduce camera shake to a minimum.

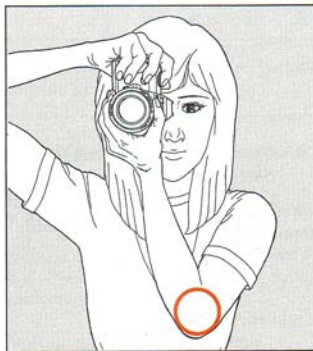

SHOOTING IN PROGRAMMED AE MODE

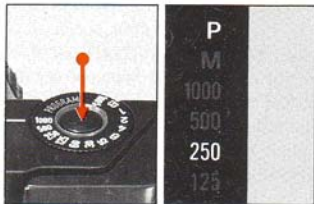
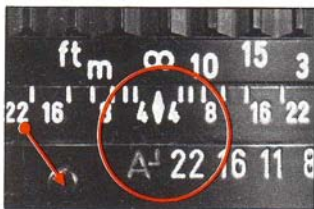

- The camera is switched to the Programmed AE mode by just setting the lens aperture to the "A" position while keeping the Auto-lock Release Button on the SMC Pentax-A lens.
- You can leave the shutter dial set at any position.
- Turn the main switch on, then press the shutter release button half-way, and you will see "P" and a shutter speed are displayed in the viewfinder. As you further press the shutter button, the shutter will be released.

- When the subject is too bright or dark, “1000” or “1” blinks as a warning. When the subject is too dark and “30” or smaller figures appear in the viewfinder, it warns that there is a danger of camera shake. In such a case, use a tripod or a flash. (For details, refer to page 27.)

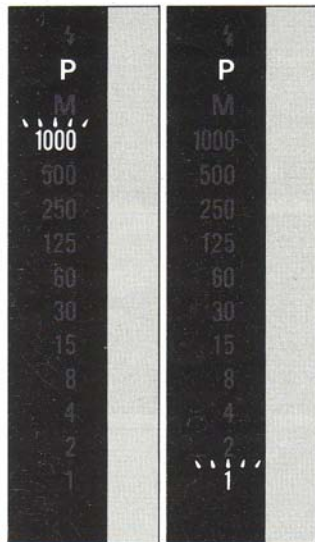

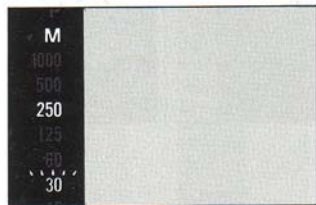
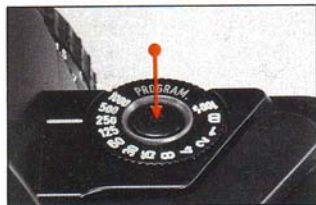

- When the lens aperture is off the "A" setting and set to any f-stop, the camera operates in the Metered Manual mode. If the aperture is set at the "A" position, release it from the position by turning the aperture ring while depressing the auto-lock-release button.
- Slightly press the shutter release button with the main switch on, and you will see "M" and a shutter speed are displayed in the viewfinder. When a shutter speed and another blinking shutter speed appear simultaneously as shown at left, it indicates incorrect exposure. Change the shutter speed or the aperture until the blinking shutter speed disappears, so that correct exposure can be obtained.

When setting shutter speed first

Set the shutter dial to the desired shutter speed. Rotate the aperture ring until the shutter-speed display changes from a blinking speed to a just glowing speed, namely, only one shutter speed is seen, so that correct exposure can be obtained. If the display does not switch from a blinking speed to a glowing speed even by turning the aperture ring, reset the shutter speed by turning the shutter dial.

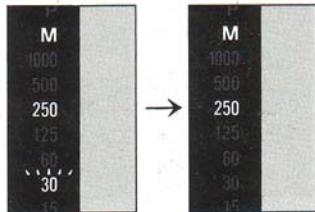

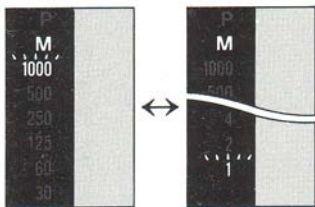
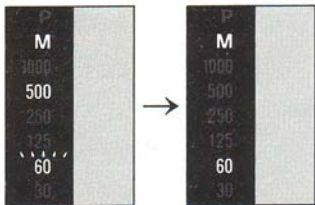

When setting aperture first

Set the aperture to your desired f-stop. Turn the shutter dial until the shutter-speed display changes from a blinking speed to a just glowing speed, namely, until only one shutter speed is seen, so that correct exposure can be obtained. If the display does not change from a blinking speed to a glowing speed even by turning the shutter dial, reset the aperture by turning the aperture ring.

- Also in the case of Metered Manual mode, when the subject is too bright or dark, "1000" or "1" blinks as a warning. Adjust the shutter speed or the aperture to obtain correct exposure. When the subject is very dark and a shutter speed slower than 1/30 is displayed, there is a danger of camera shake, and you are recommended to use a tripod or a flash. (For details, refer to page 27.)

Shutter speed display	What it means
P 1000	Beyond the metering range in Programmed AE mode. Results in incorrect exposure. "1000" or "1" blinks very quickly as a warning.
P 1	
M 500	Indicates the exposure combination is beyond the correct exposure range in Metered Manual mode. When the blinking shutter speed disappears and the other one remains lit as you change the shutter speed or the aperture, correct exposure will be obtained.
M 125	
M 250	In the Metered Manual mode, "1000" or "1" blinks at a faster rate (eight times per second).
M 60	
M 1000	In the Metered Manual mode, "1000" or "1" blinks at a faster rate (eight times per second).
M 1	
P 250	Warns that the batteries are no good. When they get weak, the shutter speed blinks very slowly at the rate of once per second.
M 250	

- All these warnings are indicated by blinking LEDs in the viewfinder.
- The beyond-the-metering-range means the situation in which the subject is too bright or dark for the meter to measure light.
- The beyond-the-shutter/aperture-coupling-range means the situation in which the combination of shutter speed and aperture is beyond the limit of use even when it is within the metering range.
- For the metering and shutter/aperture-coupling ranges,

refer to page 40.

- The symbol \ \ \ \ \ in the table indicates blinking.

When the camera warns that the exposure combination is beyond the metering range, you are recommended to do as follows:

- When the subject is too bright, use an ND filter locally on sale.
- When the subject is too dark, use a flash or some other lightings.

Using the AF200SA flash unit with this camera easily allows the Programmed Auto Flash photography with the camera set to the Programmed AE mode. You just turn the flash's switch to ON. Furthermore, the AF200T, AF280T and AF400T can also be used with this camera in the Programmed Auto Flash mode. The table indicates what dedicated functions work when the camera is used with Pentax dedicated auto flash units.

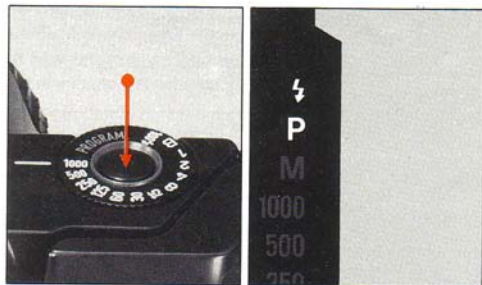

- If the AF200T, AF280T or AF400T is used with the camera in the TTL Auto Flash mode the dedicated functions are indicated in the viewfinder, but the flash emits the full light output, resulting in incorrect exposure.
- The AF200SA does not provide the dedicated function described in 3.
- AF080C, AF200S, AF160 and earlier Pentax flashes apply to 1 and 2 only in the table, when the camera is used in the Metered Manual mode.
- When the Pentax dedicated auto flash is used in its M or MS mode, the dedicated functions in the Programmed AE mode do not work.

Dedicated Functions (In Programmed Auto Flash mode)	
1	Flash-ready indication by the lighting of ⚡ mark.
2	As soon as flash is ready, shutter speed is automatically set to 1/100 sec. for flash sync.
3	When flash has worked properly, ⚡ mark in viewfinder disappears for an instant and lights up again or flickers, indicating that proper flash sync has been made.
4	In Programmed AE mode, aperture is also set automatically.

Pentax dedicated flashes can be used with this camera, regardless of whether it is set to the Programmed AE or Metered Manual mode.

1. Attach the flash to the camera.
2. Set the flash mode selector to AUTO (red, green or yellow). This does not apply to AF200SA.
3. Turn the flash switch on.
4. When the flash is ready, it is indicated by the glowing of $\$$ mark in the viewfinder. (When the meter's timer switch is off, the $\$$ mark also disappears.)



Using in Programmed AE mode

- AF200SA, AF200T, AF280T and AF400T are compatible with this mode.
- As soon as the flash is ready, the camera is automatically switched to work at the flash sync speed of 1/100. The aperture is also automatically set to the programmed f-stop as shown in the table, depending on which AUTO position you choose.

(At ISO 100)

	AF200T	AF280T	AF400T
Red	f/2.8	f/4	f/4
Green	f/5.6	f/8	f/8
Yellow	—	—	f/11

(AF200SA: f/4 at ISO 100)

- As the film speed changes, the aperture also changes automatically.
- As shown in the above table, the aperture is set to f/2.8 when the AF200T is used in the Red AUTO, and therefore, using a lens whose maximum aperture is as small as f/4, for instance, will result in underexposure.

Using in Metered Manual mode

- Set the lens aperture to the f-stop indicated by the exposure table on the back of the flash.
- As soon as the flash is ready, the camera is automatically switched to work at 1/100 sec. flash sync speed. (In Metered Manual mode, the slow-speed sync described later is workable.)

Auto Flash Check Mark (ζ)

When a proper flash photo has been taken, the ζ mark in the viewfinder disappears for an instant just after the flash firing and lights up again or blinks, indicating the completion of a proper flash photography. The AF200SA does not have this Auto Flash Check function.

Slow-Speed Sync Photography

As you set the shutter speed between 1/60 and 1 sec. with the camera set in the Metered Manual mode, you can take a slow-speed-sync photo. As soon as the flash is ready, " ζ " and "M" marks plus the shutter speed set are displayed in the viewfinder.



- (1) When the shutter speed is set between 1/1000 and 1/125 sec., the camera is automatically switched to the flash sync speed of 1/100 sec., as soon as the flash is fully charged. (In this case, no shutter speed is displayed in the viewfinder.)
- (2) When the shutter speed "1" blinks in the viewfinder as an improper exposure warning, the shutter speed disappears on completion of the battery charging, but it is automatically set to one second.

An aerial photograph of a Swiss town, likely Lucerne, featuring a river with a stone bridge and traditional buildings. The image is overlaid with a semi-transparent orange filter. The text "ADVANCED OPERATION" is centered in a bold, black, serif font.

ADVANCED OPERATION



The exposure-memory lock incorporated in this camera enables you to take an exposure reading in Programmed AE mode, lock-in that reading, move your position, and then take the picture with the programmed reading. This is useful in extremely contrasty conditions, such as when the subject is back-lit. If you are taking a portrait you can move in close to your subject and take a close-up exposure reading of the face. To hold that reading, press the memory-lock button; this will hold the reading. The exposure will remain the same as long as you press the memory-lock button.

Memory-lock not used



Used



SELF-TIMER

The self-timer is helpful for getting yourself into the photograph.

It can be set by sliding the main switch forward until the "S.T." is visible, while depressing the self-timer lever.

As you cock the film wind lever and press the shutter release button, the shutter will be released about 12 seconds later. The self-timer lamp blinks to show the self-timer is working. About two seconds before shutter release, the lamp will start to blink at a faster rate. The self-timer can be cancelled even after it has started, by sliding the main switch back to the original position.

- When you shoot at the B (Bulb) setting, the self-timer cannot be used.

Caution: When using the self-timer, you keep your eye away from the viewfinder, and light entering through the eyepiece can cause errors in exposure. This can be prevented by sliding an accessory viewfinder cap over the eyepiece, to shield the metering system from extraneous light.

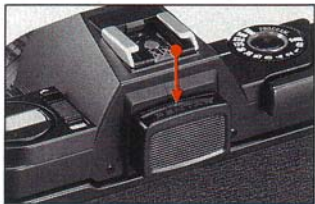
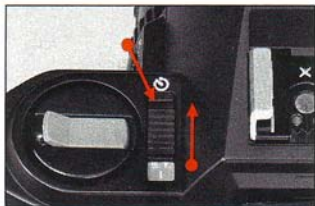

When using a conventional clip-on-type flash on this camera, set the shutter dial to "100 $\frac{1}{2}$ " (1/100 sec.).

Caution: If non-Pentax flashes whose dedicated functions are claimed to work also with cameras of other brands are used with this camera, they may well cause malfunction and damage to the electronic mechanism.



As illustrated, align "100 $\frac{1}{2}$ " with the red-line index. Set the aperture ring of your SMC Pentax-A lens to any f-stop other than A.

- When using a conventional flash, select an appropriate f-stop according to the camera-to-subject distance or the program of the flash. (Refer to the instructions accompanying the flash.)
- When using a sync-cord-type flash, use an optional accessory: Hot Shoe Adapter 2P.
- This "100 $\frac{1}{2}$ " setting can be used for non-flash photography, but since the meter does not function at this setting, you can in no way make sure of correct exposure.

USING B (BULB) SETTING

This setting is for making a long-time exposure to take pictures of fireworks, night scenes, astrophotography, etc.

- Set the shutter dial as shown. Make sure that the aperture of your SMC Pentax-A lens is set to any f-stop other than the A setting. As long as you keep depressing the shutter button, the shutter remains open. Use a sturdy tripod in this type of shooting.



DEPTH OF FIELD

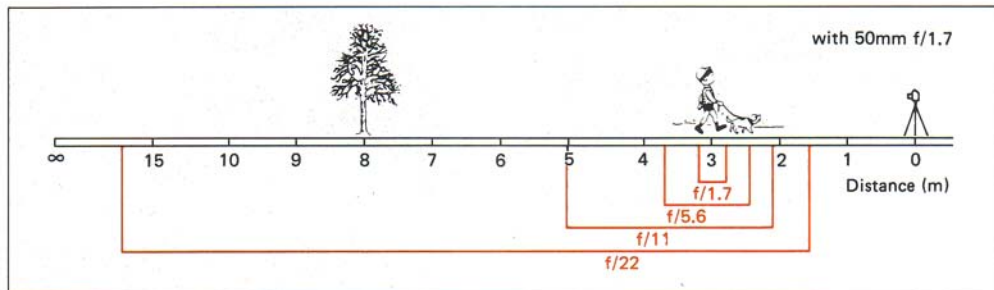

Depth of field is the area of acceptable sharpness in front of and behind the point of focus. The depth of field becomes progressively greater as the lens opening becomes smaller. The distance at which the lens is focused also affects the depth of field: it increases as you get further away. The focal length of the lens is another factor to determine the depth of field. The shorter the lens, the greater the depth of field.



f/1.7 (2.82 ~ 3.2m)

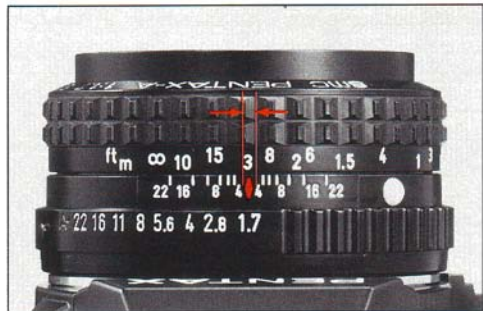

f/22 (1.67 ~ 16.9m)

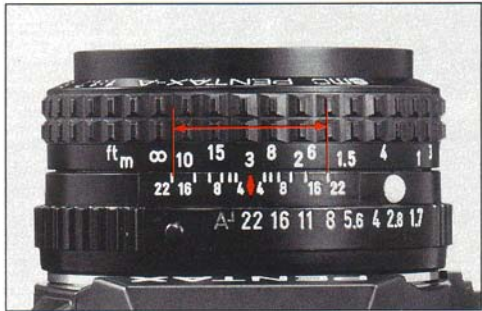



Your camera enables you to preview just what will and what will not be sharp in your pictures. By depressing the preview lever near the lens mount, you can close the lens down to whatever aperture you have set. You can then preview how much sharpness you will get in your picture by examining the picture area on the ground glass. After previewing your picture, if you release the preview lever, the lens will return to full aperture for focusing. You cannot, however, preview the depth of field with your camera set in the Programmed AE mode.

Note: Taking pictures with the preview lever depressed will result in incorrectly exposed pictures.

Depth-of-field Table: SMC Pentax-A 50mm Lens

unit=meter

Distance scale	f/1.4	f/2	f/2.8	f/4	f/5.6	f/8	f/11	f/16	f/22
0.45m	~ 0.448 ~ 0.453	~ 0.446 ~ 0.454	~ 0.445 ~ 0.455	~ 0.443 ~ 0.457	~ 0.440 ~ 0.460	~ 0.436 ~ 0.465	~ 0.431 ~ 0.471	~ 0.423 ~ 0.481	~ 0.414 ~ 0.493
0.5m	~ 0.497 ~ 0.503	~ 0.495 ~ 0.505	~ 0.494 ~ 0.507	~ 0.491 ~ 0.509	~ 0.487 ~ 0.513	~ 0.482 ~ 0.519	~ 0.476 ~ 0.527	~ 0.466 ~ 0.540	~ 0.454 ~ 0.557
0.6m	~ 0.595 ~ 0.605	~ 0.593 ~ 0.607	~ 0.590 ~ 0.610	~ 0.586 ~ 0.615	~ 0.581 ~ 0.621	~ 0.573 ~ 0.630	~ 0.564 ~ 0.642	~ 0.549 ~ 0.663	~ 0.532 ~ 0.691
0.8m	~ 0.791 ~ 0.810	~ 0.787 ~ 0.814	~ 0.781 ~ 0.820	~ 0.774 ~ 0.828	~ 0.764 ~ 0.840	~ 0.749 ~ 0.859	~ 0.732 ~ 0.883	~ 0.705 ~ 0.927	~ 0.675 ~ 0.987
1.0m	~ 0.985 ~ 1.016	~ 0.978 ~ 1.023	~ 0.970 ~ 1.032	~ 0.958 ~ 1.046	~ 0.942 ~ 1.066	~ 0.919 ~ 1.098	~ 0.892 ~ 1.140	~ 0.851 ~ 1.218	~ 0.806 ~ 1.328
1.5m	~ 1.464 ~ 1.538	~ 1.449 ~ 1.555	~ 1.430 ~ 1.578	~ 1.402 ~ 1.613	~ 1.366 ~ 1.664	~ 1.316 ~ 1.746	~ 1.259 ~ 1.861	~ 1.174 ~ 2.093	~ 1.086 ~ 2.462
2.0m	~ 1.935 ~ 2.070	~ 1.908 ~ 2.101	~ 1.874 ~ 2.144	~ 1.825 ~ 2.213	~ 1.764 ~ 2.312	~ 1.679 ~ 2.478	~ 1.584 ~ 2.724	~ 1.449 ~ 3.265	~ 1.314 ~ 4.298
3.0m	~ 2.853 ~ 3.164	~ 2.794 ~ 3.239	~ 2.719 ~ 3.346	~ 2.615 ~ 3.521	~ 2.487 ~ 3.785	~ 2.318 ~ 4.265	~ 2.137 ~ 5.073	~ 1.892 ~ 7.426	~ 1.665 ~ 16.883
10.0m	~ 8.488 ~ 12.171	~ 7.973 ~ 13.421	~ 7.375 ~ 15.552	~ 6.631 ~ 20.422	~ 5.846 ~ 35.101	~ 4.966 ~	~ 4.181 ~	~ 3.313 ~	~ 2.655 ~
∞	~ 55.370	~ 38.772	~ 27.707	~ 19.408	~ 13.876	~ 9.726	~ 7.086	~ 4.885	~ 3.565

INFRARED INDEX MARK

If you intend to take infrared photographs using infrared film and R2 or O2 filters, it is necessary to compensate for the difference between visible light focus and infrared focus. As shown on the right, note the subject-to-camera distance on the lens distance scale as you focus through the viewfinder and turn the focusing ring until that distance setting aligns with the red infrared index mark. The figure shows an example in which the subject-to-camera distance is set at infinity (∞).

For details on exposure control, refer to the instructions accompanying the film.



PROGRAMMED AE DIAGRAM, METERING RANGE AND SHUTTER/APERTURE COUPLING RANGE

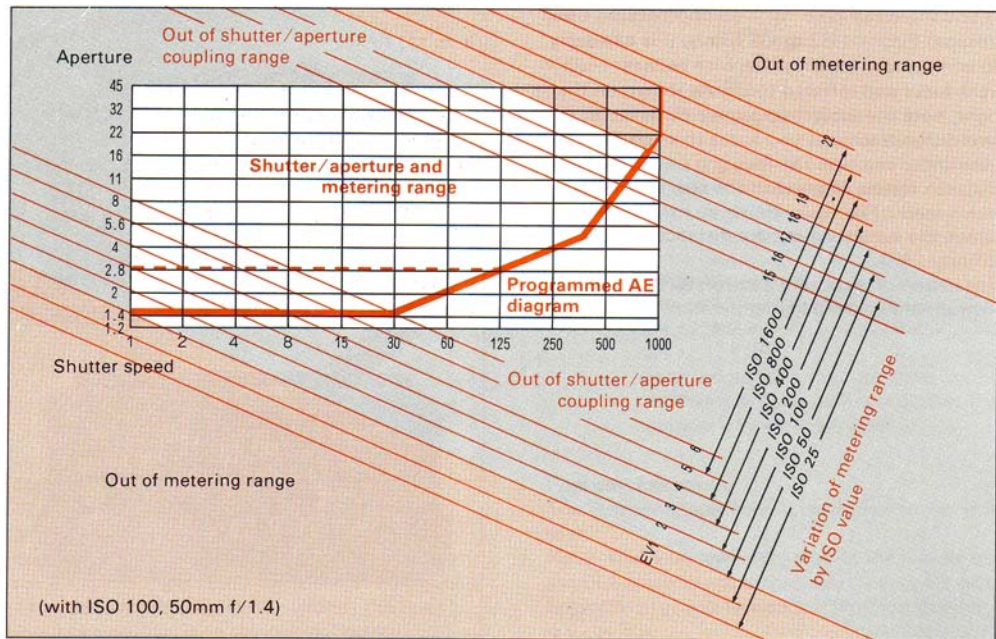

The shutter-speed and aperture combination in the Programmed AE mode is shown in the chart. The red line represents the variation of shutter-speed and aperture combination with an $f/1.4$ lens. Note that only the shutter-speed slows down after the lens aperture reaches its limit of $f/1.4$ in combination with a speed of approx. $1/30$ sec. When you use a lens with a different maximum aperture, the exposure program varies the aperture and the shutter-speed in combination until reaching the maximum aperture of your lens. For example, with an $f/2.8$ lens the program varies the combination as shown by the red dotted line. Note that only the shutter speed changes after the maximum aperture is reached. The fine red line in the Programmed AE diagram indicates the Automatic Exposure control range for a lens with minimum aperture smaller than $f/22$, or for a film with ISO speed other than 100. The fine red-dotted line indicates the range for a lens with maximum aperture smaller than $f/1.4$, or for a film with ISO speed other than 100.

Metering Range and Shutter/Aperture Coupling Range

The metering range means the range of subject luminance within which the built-in exposure-meter works to control exposure. The shutter/aperture coupling range is that part of the metering range within which shutter-speed and aperture value can be combined for proper exposure control. When you use a 50mm $f/1.4$ normal lens and an ISO 100 film, the metering range is from EV 1 ($f/1.4$ -1 sec.) to EV 18 ($f/16$ - $1/1000$ sec. or $f/22$ - $1/500$ sec.). The range varies according to film speed (ISO). The variation of the metering range is shown by slanting lines which shift ISO ratings. The frame in the center shows the meter and shutter/aperture control coupling range.

EV (Exposure Value)

EV represents a combination of the shutter-speed and the lens aperture which is determined by the film speed (ISO) and the brightness of the subject.

DIOPTER CORRECTION, MOUNT ADAPTER K

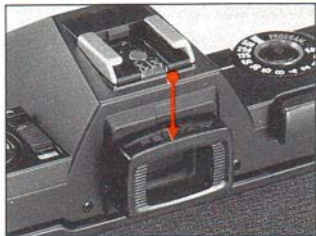

Diopter correction lenses M which fit the eyepiece on your camera are available. If you find it difficult to see the viewfinder image clearly, choose any one of the eight Correction Lenses M of -5, -4, -3, -2, -1, +1, +2, +3 diopters. Slide it into the eyepiece's accessory groove. Before buying one, try it for yourself with the lens attached to your camera.



Mount Adaptor K

If you want to use any conventional Takumar screw-mount lens on your camera it is possible by placing an optional accessory called the Mount Adapter K between the camera body and the lens. However, please note the following conditions when actually taking pictures:

- Automatic diaphragm does not work due to difference in the coupling system.
- Stop-down metering must be made.
- Automatic aperture setting with a Pentax dedicated flash is not workable.

PRECAUTIONS ON BATTERIES

- Incorrect usage of batteries causes such hazards as leakage, heating or explosions. Polarity markings should be carefully checked while inserting batteries. If either battery is erroneously inserted, unexpected mishap may occur.
- Replace both batteries at the same time. Do not mix battery brands and types, or old batteries with new batteries.
- When not using the camera for long periods of time, you should remove batteries from the camera. Old batteries are apt to leak and damage the battery compartment. Always keep batteries out of the reach of children.
- Never break, recharge, or throw used batteries into fire as a precaution against explosions.
- Batteries should be kept warm in cold climates to prevent lowering of performance.
- Keep spare batteries on hand for convenience in photographing outdoors or while traveling, etc.
- One set of alkaline batteries should last about six months and one set of silver-oxide batteries about a year, both with average use.
- When keeping the camera in a bag or case, be sure to turn the main switch off avoid the unnecessary consumption of battery power that may result from accidentally releasing the shutter.

SPECIFICATIONS

Type:	Through-the-lens, programmed-AE 35mm SLR camera.
Film:	35mm film, 24 x 36mm. Automatic film speed setting from ISO 25 to 1600 (in 1/3 steps) with DX-coded film.
Lens Mount:	Pentax KA bayonet mount.
Exposure Modes:	Programmed AE, Metered Manual and Programmed Auto Flash.
Shutter:	Seiko MFC E7 vertical-run focal plane shutter. Electro-magnetic shutter release. Electronically controlled stepless automatic speeds from 1 to 1/1000 sec., manually-set shutter speeds from 1 to 1/1000 sec. (11 steps) and "B".
Viewfinder:	Silver-coated pentaprism finder with split-image/micropism/matte focusing screen (Clear-Bright-Matte). Shows 92% of picture area at 0.82X magnification with 50mm lens at infinity. -1 diopter eyepiece.
Exposure Indication in Viewfinder:	LED indicators for "S" (flash ready), "P" (Programmed AE mode), "M" (Metered Manual mode), and 11 shutter speeds (green LED for "1000" to "60"; yellow for "30" to "1"). Warnings for exposure setting outside aperture/shutter-speed coupling range ("1000" or "1" LED blinks at 8Hz.)
Flash Synchronization:	Hot shoe (X-Sync contact, dedicated flash contacts), X-Sync at 1/100 sec.
Self-Timer:	Electronically-controlled 12-second delay timer. Delay time indicated by blinking LED. Possible to cancel at any time. Timer activated with shutter release button.
Mirror:	Back-swing type instant-return mirror.
Film Loading:	Easy loading type.
Film Transport:	Single-stroke rapid wind lever with 130° throw and 35° stand-off angle.
Film Counter:	Additive type with automatic resetting.
Film Rewind:	Crank type.

Exposure Metering:	Open-aperture, TTL center-weighted, average area metering system with GPD cell.
Metering Range:	EV 1 (f/1.4, 1 sec.) – EV 18 (f/16, 1/1000 sec.) with 50mm f/1.4 lens and ISO 100 film.
Exposure Memory Lock:	With the exposure memory lock button.
Battery Warning:	When batteries grow weak, LED flashes. When batteries exhausted, LEDs go blank and shutter locks.
Power Source:	Two 1.5V silver-oxide or alkaline batteries.
Size & Weight:	137(W) x 87.5(H) x 50.5(D)mm (5.3" x 3.4" x 2.0"), 510g (17.9 oz.) without batteries.

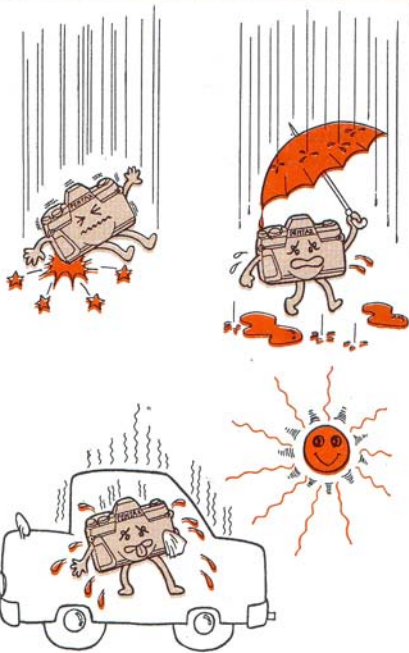

Your Pentax camera is a sophisticated, precision instrument built to give long-lasting, reliable service. It will serve you well if you treat it right, with proper handling and reasonable care. The major causes of damage are:

1. Dropping or banging the camera against immovable objects, which can damage the camera in many ways.
2. Water damage, particularly if the camera is submerged in salt water. Cameras are not water-proof! They must be protected from salt spray at the beach, splashing of any kind, and shielded from the rain. If your camera does get soaked, wipe it dry immediately and rush it to a Pentax service center.
3. Dirt and sand can cause serious damage to the shutter and other moving parts of the camera. Your camera needs periodic cleaning to keep it operating properly. To remove dirt and dust, you need lens-cleaning fluid, lens-cleaning tissues, bulb-type ear syringe, camel's hair brush, etc. Never use a solvent such as thinner or alcohol.
4. Humidity and temperature extremes should be avoided. Keep your camera out of direct sunlight, car trunks, and glove compartments. Shooting

outdoors in winter presents a problem since batteries won't function if they get too cold. In cold weather carry your camera under your coat or jacket to keep the batteries warm. The temperatures at which this camera should function properly are approx. $50^{\circ} \sim -10^{\circ}\text{C}$. Sudden changes in temperature will often cause moisture to condense inside or outside your camera. This is a possible source of rust, which may be extremely harmful to the mechanism. Furthermore, if the camera is taken from a warm temperature to a sub-freezing one, further damage may result from the formation of icelets. Thus, sudden temperature changes should be avoided as much as possible. As a guide, a temperature change of 10°C should be allowed to take place gradually over a period of at least 30 minutes. If this is not possible, keeping the camera in its case or bag will help somewhat in minimizing the effects of a rapid temperature change.

5. Vibration experienced when you are traveling in a car, plane, or ship, can cause screws to loosen. To minimize this problem use foam-rubber padding about one inch thick to line the bottom of your camera bag.

6. When mounting your camera on a tripod, make sure the tripod screw is no longer than 5.5mm, which is the depth of your camera's tripod socket. If you use a longer screw, you will possibly puncture the tripod socket, after which the camera will not function properly.

All Pentax cameras purchased through authorized bona fide photographic distribution channels are guaranteed against defects of material or workmanship for a period of twelve months from date of purchase. Service will be rendered and defective parts will be replaced without cost to you within that period, provided the equipment has not been abused, altered, or operated contrary to instruction. Because the tolerances, quality, and design compatibility of lenses other than Pentax lenses are beyond our control, damage caused by use of such lenses will not be covered by this warranty policy. The manufacturer or its authorized representatives shall not be liable for any repair or alterations except those made with its written consent and shall not be liable for damages from delay or loss of use or from other indirect or consequential damages of any kind, whether caused by defective material or workmanship or otherwise; and it is expressly agreed that the liability of the manufacturer or its representatives under all guarantees or warranties, whether expressed or implied, is strictly limited to the replacement of parts as hereinbefore provided.

Procedure During 12-month Warranty Period

Any Pentax which proves defective during the 12-month warranty period should be returned to the dealer from whom you purchased the equipment or to the manufacturer. If there is no representative of the manufacturer in your country, send the equipment to the manufacturer, with postage prepaid. In this case, it will take a considerable length of time before the equipment can be returned to you owing to the complicated customs procedures required in Japan in importing and re-exporting photographic equipment. If the equipment is covered by warranty, repairs will be made and parts replaced free of charge, and the equipment will be returned to you upon completion of servicing. If the equipment is not covered by warranty, regular charges of the manufacturer or of its representatives will apply. Shipping charges are to be borne by the owner. If your Pentax was purchased outside of the country where you wish to have serviced during the warranty period, regular handling and servicing fees may be charged by the manufacturer's representatives in that country. Notwithstanding this, your Pentax returned to the manufacturer will be serviced

free of charge according to this procedure and warranty policy. In any case, however, shipping charges and customs clearance fees are to be borne by the sender. To prove the date of your purchase when required, please keep the receipts or bills covering the purchase of your equipment for at least a year. Before sending your equipment for servicing, please make sure that you are sending it to the manufacturer's authorized representatives or their accredited repair shops, unless you are sending it directly to the manufacturer. Always obtain a quotation of the service charge, and only after you accept the quoted service charge, instruct the service station to proceed with the servicing.

This warranty policy does not apply to Pentax products purchased in the U.S.A., U.K., or Canada. The local warranty policies available from Pentax distributors in those countries supersede this warranty policy.

PENTAX®



Asahi Optical Co., Ltd. C.P.O. 895, Tokyo 100-91, JAPAN
Pentax Europe n.v. Weveldlaan 3-5, 1930 Zaventem Zuid-7, BELGIUM
Pentax Handelsgesellschaft mbH Postfach 54 0169, 2000 Hamburg 54, WEST GERMANY
Pentax U.K. Limited Pentax House, South Hill Avenue, South Harrow, Middlesex HA2 0LT, U.K.
Pentax France S.A. Z.I. Argenteuil, 12, Rue Ambroise-Croizat, 95100 Argenteuil, FRANCE
Pentax (Schweiz) AG Industriestrasse 2, 8305 Dietlikon ZH, SWITZERLAND
Pentax Svenska AB Box 650, S-751 27 Uppsala, SWEDEN
Pentax Nederland Spinveld 25, 4815 HR Breda, THE NETHERLANDS
Pentax Norge A/S Stenersgt. 18, Oslo 1, NORWAY
Pentax Corporation 35 Inverness Drive East, Englewood, Colorado 80112, U.S.A.
Pentax Canada Inc. 1760 West 3rd Avenue, Vancouver, B.C. V6J 1K5, CANADA
Asahi Optical Brasileira Ind. e Com. Ltda. Rue Capitão Antonio Rosa 376, Sala 121 Ed. PBK, São Paulo, BRASIL

Specifications are subject to change without notice.

08191/ENG

Copyright © Asahi Optical Co., Ltd. 1985

8 85 Printed in Belgium